



Güralp 3TB

Operator's Guide

Document No. MAN-BHO-0001

Issue G, November 2019

Designed and manufactured by
Güralp Systems Limited
3 Midas House, Calleva Park
Aldermaston RG7 8EA
England

Table of Contents

1 Preliminary Notes.....	4
1.1 Proprietary Notice.....	4
1.2 Warnings, Cautions and Notes.....	4
1.3 Manuals and Software.....	4
2 Introduction.....	5
2.1 System configuration.....	6
2.2 Digital borehole installations.....	7
2.3 The hole lock system.....	8
2.3.1 The single-jaw hole lock.....	8
2.3.2 The three-jaw hole lock.....	10
3 First encounters.....	11
3.1 Unpacking and packing.....	11
3.2 Handling notes.....	11
3.3 Control units.....	12
3.3.1 The break-out box.....	12
3.3.2 The hand-held control unit.....	14
3.3.3 The inclinometer monitor unit.....	16
3.4 Operating the hole-lock.....	17
3.4.1 Disengaging the hole lock.....	18
3.5 The surge suppressor sonde.....	20
3.6 Using Baffles.....	21
4 Installing the 3TB in a borehole.....	22
4.1 Installing a sensor with hole lock unit.....	22
4.2 Installing a sensor using sand backfill.....	26
4.2.1 Procedure.....	27
4.3 Assembling the winch.....	31
4.4 Earthing a borehole sensor.....	35
4.4.1 Installations with AC power supplies.....	36
4.4.2 Installations with DC power supplies.....	38
4.4.3 External lightning protection.....	40

4.5	Levelling and Centring.....	40
4.6	Down-hole orientation.....	41
4.6.1	Installing the Scream! extension.....	42
4.6.2	Installing the reference instrument.....	42
4.6.3	Measuring the orientation.....	42
4.6.4	Applying automatic rotation.....	48
<hr/>		
5	Calibrating the 3TB.....	51
5.1	The calibration pack.....	51
5.1.1	Poles and zeroes.....	51
5.1.2	Frequency response curves.....	53
5.1.3	Obtaining copies of the calibration pack.....	54
5.2	Calibration methods.....	54
5.3	Calibration with Scream!.....	55
5.3.1	Sensor response codes for 3TB instruments.....	58
5.4	Calibration with a hand-held control unit.....	58
5.5	The coil constant.....	58
<hr/>		
6	Inside the 3TB.....	60
6.1	The sensors.....	60
6.2	The control system.....	61
6.2.1	LOCK.....	62
6.2.2	UNLOCK.....	63
6.2.3	CENTRE.....	65
6.3	The feedback system.....	66
6.3.1	Hybrid feedback.....	67
6.3.2	Conventional-response feedback.....	68
6.3.3	Comparisons.....	68
<hr/>		
7	Connector pin-outs.....	70
7.1	Break-out Box – Power connector.....	70
7.2	Break-out Box – Recorder and Control connectors.....	71
7.3	Break-out Box – Sensor connector.....	72
7.4	Instrument - Sensor Connector.....	73
<hr/>		
8	Specifications.....	74
<hr/>		
9	Revision history.....	76

1 Preliminary Notes

1.1 Proprietary Notice

The information in this document is proprietary to Güralp Systems Limited and may be copied or distributed for educational and academic purposes but may not be used commercially without permission.

Whilst every effort is made to ensure the accuracy, completeness and usefulness of the information in the document, neither Güralp Systems Limited nor any employee assumes responsibility or is liable for for any incidental or consequential damages resulting from the use of this document.

1.2 Warnings, Cautions and Notes

Warnings, cautions and notes are displayed and defined as follows:



Warning: A black cross indicates a chance of injury or death if the warning is not heeded.



Caution: A yellow triangle indicates a chance of damage to or failure of the equipment if the caution is not heeded.



Note: A blue circle indicates indicates a procedural or advisory note.

1.3 Manuals and Software

All manuals and software referred to in this document are available from the Güralp Systems website, www.guralp.com, unless otherwise stated.

2 Introduction

The Güralp 3TB is a three-axis seismometer consisting of three sensors stacked vertically in a sealed borehole sonde, designed for use in cased boreholes with diameters between 99 mm (≈ 3.9 ") and 203 mm (≈ 8 ").

The seismometer system is self-contained except for its 12 – 30 V power supply, which is provided through the same cable as the analogue data. Sensor functions such as levelling and mass locking are carried out through a surface control box.

The 3TB's sensors are sensitive to ground vibrations across the entire seismic spectrum, with a flat response to velocity in the frequency range 0.0027 Hz (360 seconds) to 50 Hz. It outputs analogue voltages representing ground velocity on balanced differential lines. Each seismometer is delivered with a detailed calibration sheet showing its serial number, measured frequency response in both long and short period sections of the seismic spectrum, sensor DC calibration levels, and the transfer function in poles/zeros notation.



2.1 System configuration

The Güralp 3 series of seismic instruments share a number of features:

- a modular sensor sonde, which can be fitted with a single-jaw or three-jaw hole-lock mechanism as required,
- a pit-head installation including a breakout box, and
- a number of additional, optional control units which may be connected to the breakout box to perform installation and maintenance tasks.

For example, a borehole or pit installation of a 3TB or 3ESPB instrument with single-jaw hole lock has the following layout:

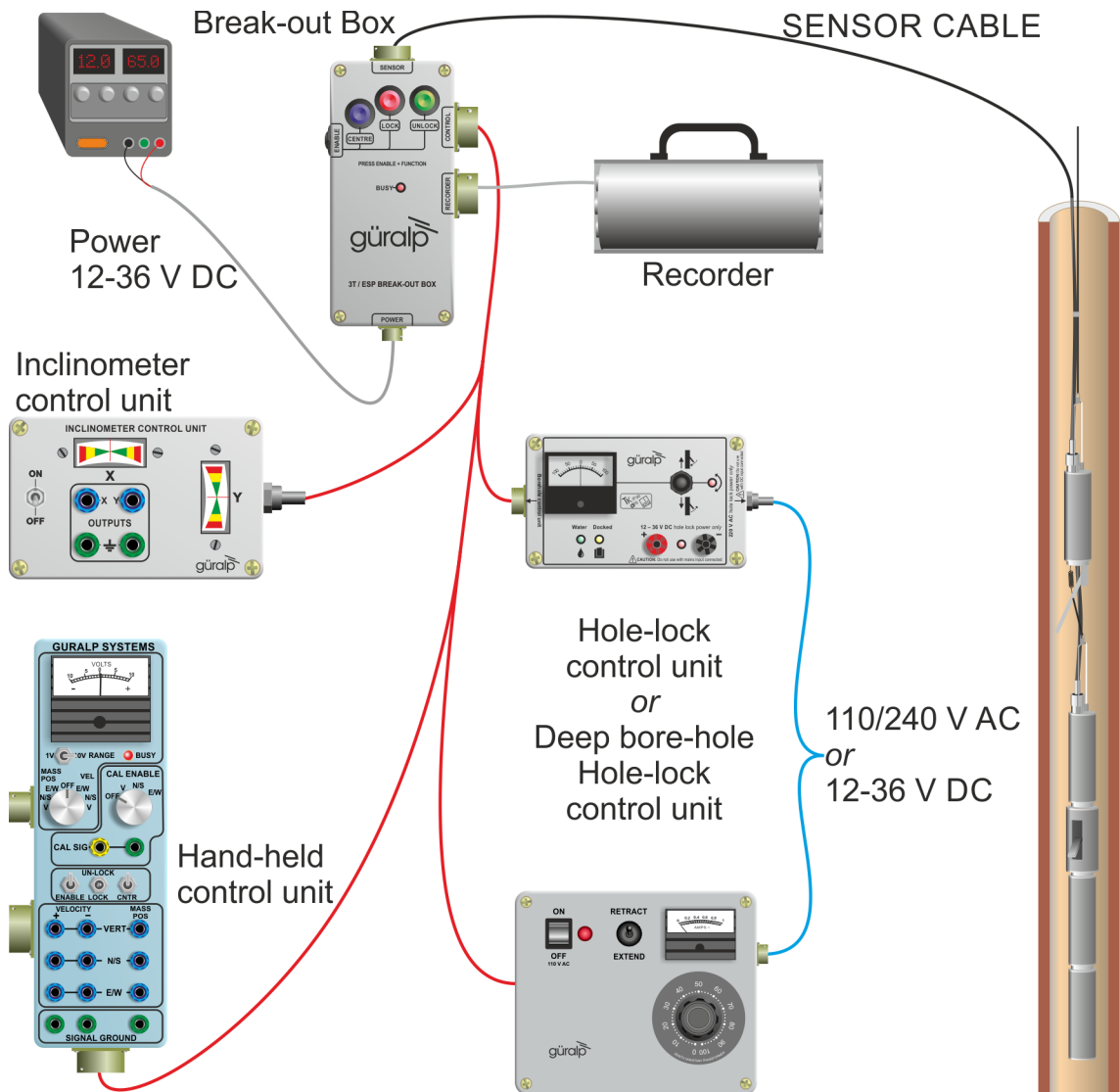

Güralp 3-series instruments are also suitable for installing in boreholes with sand back-fill. In this case no hole lock unit is necessary.

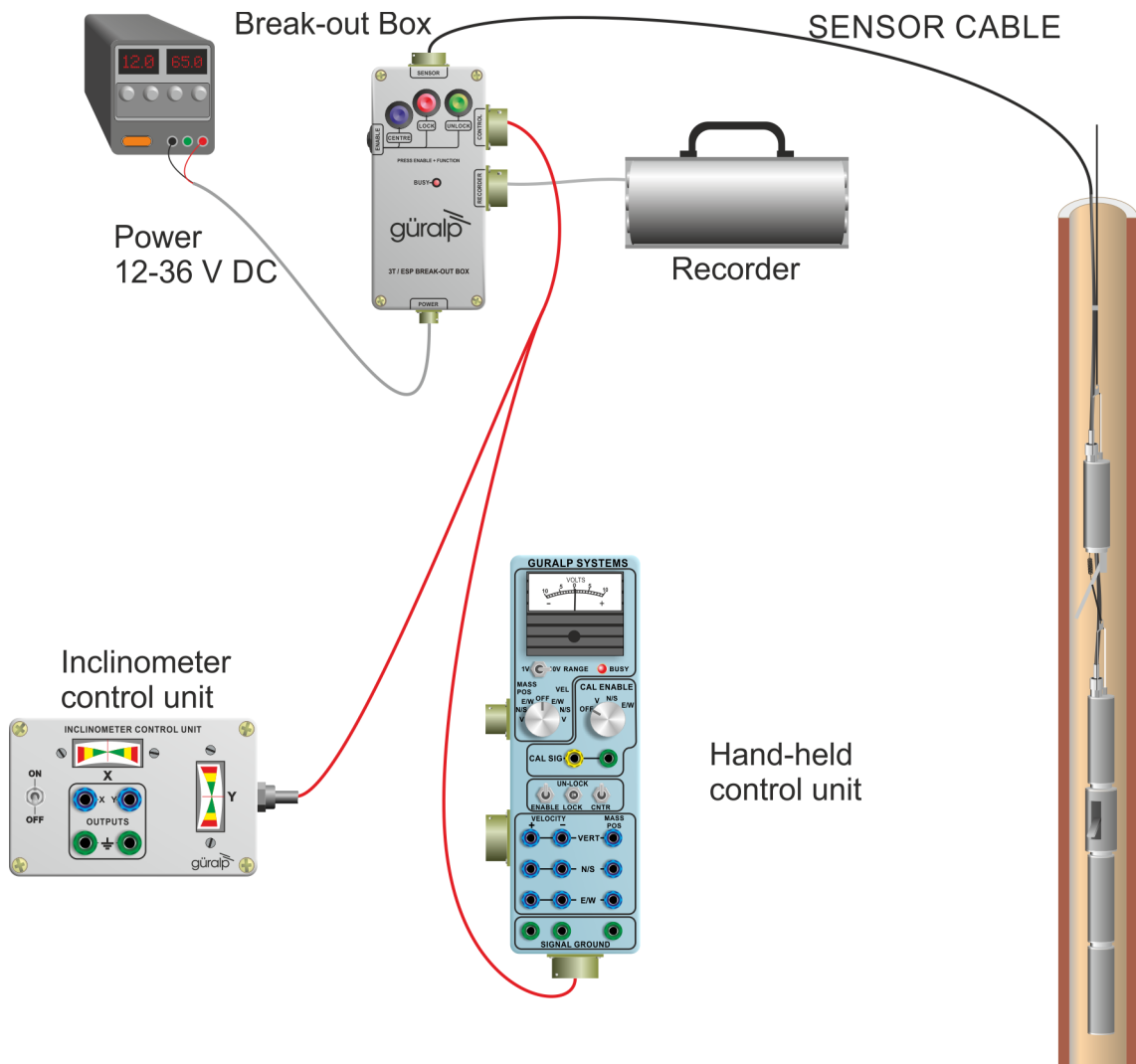

The 3V sensor is identical to the vertical-component module of the 3TB instrument, allowing you to build mixed arrays of 3V and 3TB sensors with identical response characteristics.

2.2 Digital borehole installations

The Güralp DM24 digitizer is available in a borehole sonde form. Connecting a Güralp borehole instrument to a down-hole digitizer allows you to construct a true digital borehole installation. This has several advantages over a traditional borehole set-up:

- Digital signals are not subject to attenuation as they travel up to the surface, so signals received are stronger and more reliable.

- Digitizing the data at source allows you to ensure that its origin can be reliably traced.
- The DM24 digitizer may also be combined with an Authentication Module within the borehole sonde, allowing you to generate cryptographically-signed data at the point of origin.

A digital borehole installation can be provided with RS232, RS422 or fibre-optic links to the surface, depending on the depth of the borehole and the distance from the well-head to the surface controller (i.e. the total cable length).

When a down-hole digitizer is present, it takes the place of the strain relief unit in the borehole. The surface unit also takes a slightly different form, with a serial connector allowing you to attach a modem or other communications link. In this type of installation, instead of using the surface unit to pass control signals to the sensor, all functions are accessed remotely via the digitizer.

If you prefer to install a stand-alone digitizer at the surface, it should be connected to the 26-pin "RECORDER" socket of the breakout box.

2.3 The hole lock system

The hole lock clamp unit in a 3TB instrument provides a stable platform for the sensor modules mounted above and below it. It is designed to maintain a positive pressure on the borehole casing over a prolonged period of time without attention, and to fix the sonde in place whilst avoiding transmitting any stresses.

Güralp Systems hole locks are constructed to order from accurate measurements of your borehole at the depth you wish to install the instrument. Either single-jaw or three-jaw hole lock units can be manufactured.

In installations with sand back-fill, or where the instrument rests on the bottom of the borehole, a hole lock may be unnecessary.

2.3.1 The single-jaw hole lock

The single jaw hole lock is the standard option for triaxial borehole instruments. It consists of an active clamp arm and a number of skids or studs on the sonde body. The arm is attached to a compression spring, which forces it to swing out from the sonde and wedge the body against the borehole wall. A textured steel jaw at the end of the arm provides maximum grip against the borehole casing. The skids or studs and the locking arm together form a multi-point clamp, which aligns the sonde body parallel to the axis of the borehole and holds it firmly in place so that it cannot twist or slip under the influence of ground vibrations.

There are several configurations of skids and studs which can provide a suitable clamp. Either

- the locking jaw pushes two steel skids against the side of the borehole, providing two line contacts;
- only the tips of the skids come into contact with the borehole, providing three point contacts;
- a single skid is combined with a pad to provide one line and one point contact; or
- three studs provide three point contacts.



Studs have the advantage of being smaller than skids, but the contact points are very close to each other. You should evaluate the various locking methods available to see which works best in your borehole.

The spring inside the lock provides around 60 kg of force at its locking position. A DC actuator retracts the arm into the body of the lock so that the sensor mechanism can be installed and removed. The actuator consists of a 14 W DC motor with a planetary reduction gear-head, which drives the nut of a ball lead screw through the helical drive gears. The thread of the lead screw is prevented from turning, and so moves linearly when the nut turns.



The motor has a power system separate from that of the sensor, and can be controlled from the surface using a hole lock control unit. Once the sonde is installed, the hole lock control unit may be removed. Without power, the hole lock will not be able to retract, and the sensor will be secured.

2.3.2 The three-jaw hole lock

A three-jaw hole lock is available which gives better grip on the borehole casing, but is bulkier and heavier than the single-arm lock. This is the standard option for uniaxial instruments; it can be installed in boreholes between 99 mm (≈ 3.9 ") and 203 mm (≈ 8 ") in diameter.

The three-jaw hole lock consists of a set of three active clamp arms attached to a compression spring, which forces them to swing out from the sonde and wedge themselves against the borehole wall. Serrated steel jaws at the end of each arm provides maximum grip against the borehole casing. This configuration ensures that the sonde body is held parallel to the axis of the borehole and prevented from twisting or slipping under the influence of ground vibrations.



3 First encounters

3.1 Unpacking and packing

The 3TB seismometer is delivered in a single transportation case, with the sensor system and hole lock mechanism (if ordered) packed separately. The packaging is specifically designed for the 3TB and should be reused whenever you need to transport the sensor. Please note any damage to the packaging when you receive the equipment, and unpack on a clean surface.

The package should contain:

- the seismometer;
- a cable to join the sensor to the breakout box;
- the breakout box;
- the hole lock control unit (optional);
- a cable strain relief mechanism or combined cable strain relief mechanism and surge suppressor;
- a Hand-held Control Unit (HCU) for monitoring sensor outputs and calibration, if ordered; and
- a calibration data sheet.

The sensor is securely packed, and you will need to remove most of the foam packing before it can be removed.

3TBs used to be delivered in sections which had to be assembled by the user. They are now shipped complete and no assembly is required. If you are working with a disassembled unit and need assembly instruction, please contact support@guralp.com for an earlier version of this manual. If you need to transport a unit but the packaging you have requires disassembly of the instrument, please contact support@guralp.com for an up-to-date shipping container.

3.2 Handling notes

The 3TB is a sensitive instrument, and is easily damaged if mishandled. It will not stand vertically upwards without support, and should not be operated until it has been securely installed in a borehole casing. If you are at all unsure about the handling or installation of the device, you should contact Güralp Systems for assistance.

- Do not bump or jolt any part of the sensor when handling or unpacking.

- Keep the sonde sections vertical wherever possible. Carry them by hand and store in a safe rack. Never drag or roll the sonde.
 - Never lay the sonde horizontally whilst the sensors are unlocked. If the sensor system topples over, you must inform Güralp Systems.
 - Keep all the parts of the sensor system protected and clean so that they can be joined together securely. Store in the original packaging if possible.
 - Do not kink or walk on the data cable (especially on rough surfaces such as gravel), nor allow it to bear the weight of the sensor.
 - Do not connect the instrument to power sources except where instructed.
-

3.3 Control units

The 3TB is operated from the surface through various control units. All the 3TB's functions can be accessed through one or other unit. Most can be removed from the site once the instrument is ready for use.

Some of these control units are optional and may not have been supplied with your installation. Their functions can be duplicated either by directly grounding control lines (see appendixes for pin-out information) or through a connected Güralp digitizer such as the Güralp DM24. The DM24 digitizer is able to pass commands to the instrument from an Enhanced Acquisition Module (Güralp EAM) or a computer running Güralp Systems' Scream! software, allowing you to access all of the instrument's functions remotely.

3.3.1 The break-out box

The break-out box is normally placed where the signal cable emerges from the borehole. It provides connectors for attaching the various other control units, supplies power to the instrument and relays output signals to a recorder or digitizer. It is not required when a down-hole digitiser is used.

- The *SENSOR* connector is a 26-way military-specification bayonet plug, and should be connected to the borehole instrument using the cable provided.
- The *RECORDER* connector is a 26-way military-specification bayonet plug. This should be connected to an analogue data recorder or stand-alone digitizer.

- The *CONTROL* connector is a 26-way military-specification bayonet plug intended for connecting to an external controller or Hand-held Control Unit. It has the same pin out as the *RECORDER* connector.
- The *POWER* connector is a 10-way military-specification bayonet plug, which should be connected to a source of 12 – 30 V DC power, for supplying to the borehole instrumentation. When operating the hole lock, you should connect the Hole-lock Control Unit to this connector. Because of the potentially high voltages and currents used, the hole lock circuitry is entirely isolated from the rest of the electrical systems in the sensor and surface unit; it is not usual to power the sensor whilst using the hole lock.



For deep-borehole installations (over 50 metres) may be necessary to use a modified instrument (with “active-high” logic) and a breakout box with internal line drivers, to ensure that logic signals are reliably transmitted to the sensor. Contact Güralp Systems for advice.



Note: The breakout box looks very similar to other Güralp breakout boxes. However, its internal wiring is different from that used for some other instruments. For this reason, if you are using several instrument types, you should mark each breakout box clearly so that it is always used with the correct instrument.

3.3.1.1 Calibration

To calibrate the instrument, the *Calibration enable* line must be activated. This operates a relay which allows a calibration signal to flow through the transducer feedback coil. This provides an extra force acting on the sensor masses, producing a corresponding deflection in the output signal, which can be analysed by a control computer to extract the seismometer's response characteristics.

Most Güralp instruments are manufactured with “active-low” *Calibration enable* lines, which are normally left floating but are grounded to initiate calibration. Instruments with active-high calibration can be manufactured on request.

3.3.1.2 Mass locking and unlocking

The 3TB is delivered with its sensor masses locked, so that they will not be damaged in transit. You should lock the masses whenever you need to move the instrument.

To unlock the instrument, hold down the *ENABLE* and *UNLOCK* buttons (or the *UNLOCK* switch on a breakout box) for at least six seconds. The sensor's

microcontroller will free the vertical, N/S and E/W sensor masses in turn and ready them for use. Once this is done, the controller automatically starts a centring cycle. If you issue an *UNLOCK* command when the masses are already free, the instrument will attempt to lock the masses first, and then unlock them in sequence as normal.

To lock the instrument, hold down the *ENABLE* and *LOCK* buttons (or the *LOCK* switch) for at least six seconds. The sensor's microcontroller will lock the vertical sensor mass, followed by the N/S and E/W sensor masses in turn. After this, the controller locks the base of the horizontal instrument, tilting it until it is held against its end stop. The instrument is now protected against accelerations up to 10g, and is ready for transportation.

3.3.1.3 Centring

To centre the instrument, hold down *ENABLE* and *CENTRE* buttons (or the *CENTRE* switch) for at least six seconds. If the masses are locked, the microcontroller will do nothing. Otherwise, it attempts to zero the output of the vertical, E/W, and N/S sensors in sequence by exerting a small extra force on the boom. For the vertical sensor, a motor-driven adjuster presses a small spring lever against the boom until the mass position output indicates an offset close to zero. In the case of the horizontal sensors, the sensor frame is tilted on its base plate. Again, the controller monitors the mass position sensor and stops the centring process once it reaches its lowest offset.

After successful centring, the mass position outputs should be in the range 0.1 – 0.8 Volts. If the centring process leaves the mass position outputs above ± 1.1 V, start another centring cycle. You will probably need to perform several rounds of centring before the masses are ready.

3.3.2 The hand-held control unit

This portable control unit provides easy access to the seismometer's control commands, as well as displaying the output velocity and mass position (*i.e.* acceleration) on an analogue meter.

3.3.2.1 Connections

The HCU provides

- two identical 26-pin, military-specification bayonet connectors for attaching to the *HCU* or *RECORDER* connectors of the breakout box, and
- a 10-pin, military-specification bayonet connector through which you can power the instrument, if desired. The power pins on this connector are directly connected to those on the *SENSOR POWER* connector of the breakout box. When using this alternative power connection, you should ensure you do not inadvertently connect two power supplies together.

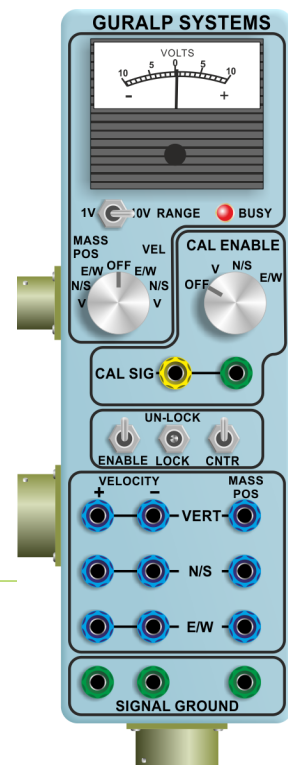

3.3.2.2 Signal meter

The upper section of the HCU contains a simple voltmeter for monitoring various signals from the instrument.

- To monitor the velocity outputs, switch the dial to *V*, *N/S* or *E/W VEL* according to the component you want to monitor.
- To monitor the mass position outputs, switch the dial to *V*, *N/S* or *E/W MASS POS* according to the component you want to monitor.
- You can set the range of the meter with the *RANGE* switch. When switched to 10 V, the meter ranges from -10 to $+10$ V (as marked). When switched to 1 V, the range is -1 to $+1$ V.

3.3.2.3 Calibration and control

You can calibrate a 3TB sensor through the HCU by connecting a signal generator across the yellow and green *CALIBRATION SIGNAL* inputs. The *CAL ENABLE* dial must be set to 'V' – the 3TB has only one calibration enable line and this acts on all components simultaneously. The sensor's response can now be monitored or recorded, and calibration calculations carried out.

The section of the HCU below the calibration lines controls the instrument's mass control system. To initiate locking, unlocking, or centring, hold down the *ENABLE* switch on the HCU *together with* the appropriate switch for the command you want to issue for at least six seconds.

3.3.2.4 Banana plugs

The remainder of the HCU provides useful connections for each of the signal lines from the instrument, for attaching to your own equipment as necessary.

3.3.3 The inclinometer monitor unit

All 3TB borehole sensor systems can operate successfully in boreholes with tilt angles of up to 3.5° from the vertical although instruments which can operate at tilts of up to 12° are available – please contact Güralp Systems for details. To check that the instrument is installed suitably close to the vertical, a two-axis inclinometer is installed within the sensor housing. The inclinometer monitor unit is used as a visual guide to the sensor's tilt only, and should not be used if precise attitude information is required.



Caution: You should check the inclination of the instrument before unlocking the sensor masses, since too great a tilt can damage the components.

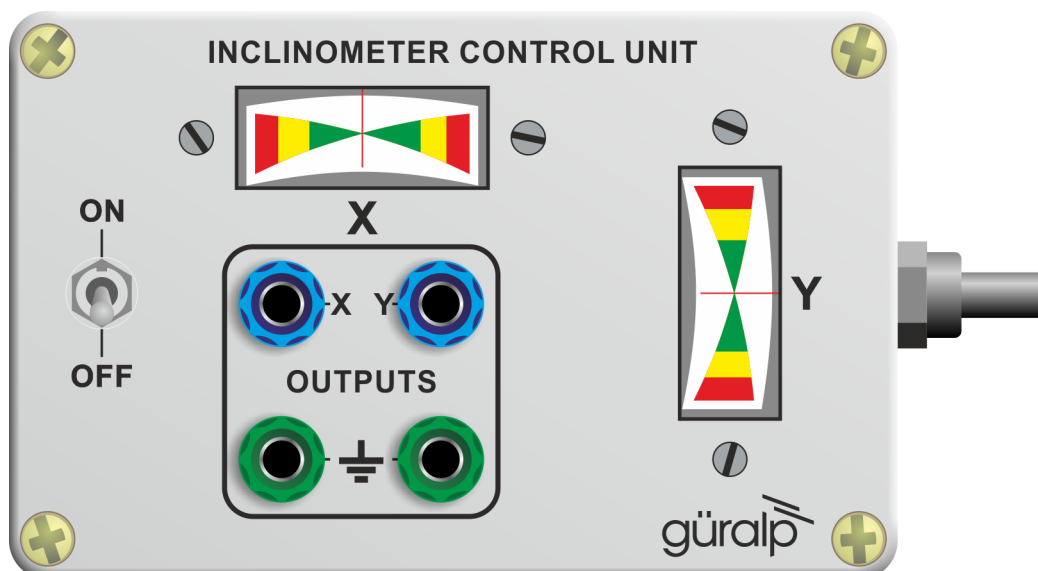

To measure the attitude of a 3TB instrument:

1. Connect the inclinometer monitor unit to the *CONTROL* connector of the breakout box.
2. Switch the *ON/OFF* switch on the monitor unit to the *ON* position. The inclinometer is powered separately from other parts of the system; this switch provides power to the downhole circuitry as well as to the monitor unit. The inclinometer should not normally be powered up whilst the sensor is in use.
3. Read off the *X* and *Y* components of the tilt from the analogue meters.
4. If both tilts are within the green shaded region, the instrument is close enough to vertical that it can be levelled and centred successfully. If either output is in the red shaded region, you should *not* attempt to unlock or centre

the sensor masses. Instead, if possible, you should move the instrument within the borehole to a place where it can lie closer to vertical.

If you need to use the outputs of the inclinometer for some other purpose, you can also connect a multimeter to the banana sockets on the inclinometer monitor unit.

3.4 Operating the hole-lock

The hole lock, if fitted, can be extended and retracted using the hole lock control unit:

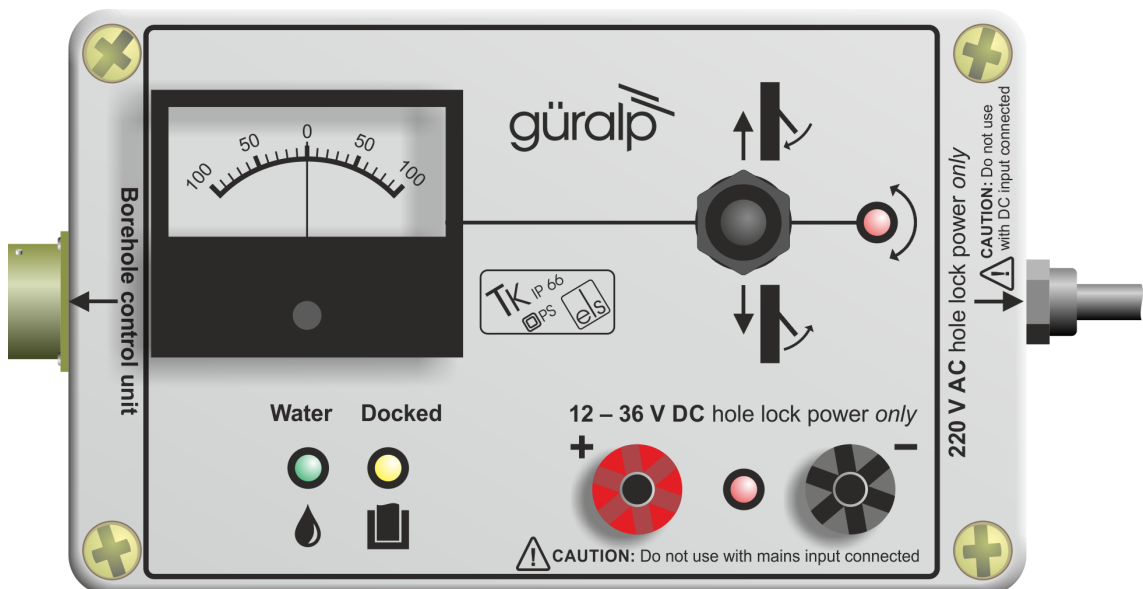

Warning: The hole lock may be using high-voltage mains (outlet) power.

To operate the hole-lock:

1. Connect the hole-lock control unit to the HOLELOCK POWER connector of the breakout box, and to a mains power supply. Alternatively, connect a 12 – 24 V DC power supply across the input terminals of the hole lock control unit.



Caution: Do not connect both DC and mains power at the same time.

The hole-lock control unit supplied in regions with 220 V AC mains power differs from that supplied for 110 V AC mains power. You should ensure that you provide the correct voltage to the hole lock control unit, otherwise damage may result to the sensor.

2. If you are using a deep-borehole hole lock control unit, set the dial to zero.

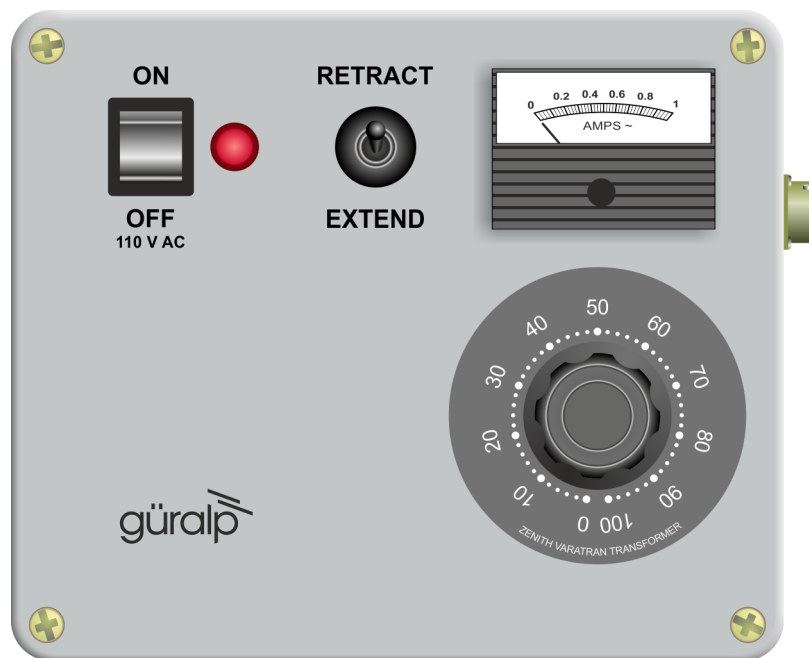

Engaging the hole lock

To extend the jaw of the hole lock:

1. Hold the switch on the hole lock control unit in the EXTEND JAW or + position. If you are using a deep-borehole control unit, there will be an additional dial compared to the unit pictured; turn this until the built-in ammeter reads around 0.1 A.
2. When the arm makes contact with the borehole casing, the current will drop slightly. Continue holding the switch in the EXTEND JAW position.
3. When the lock arm reaches its fully extended position, the motor will automatically stop and the current will drop to zero. If using a deep-borehole unit, return the dial to zero.
4. If the current has not dropped quite to zero after 30 – 40 seconds of operation, release the switch, wait a few seconds, and push it back to the EXTEND JAW position briefly. If the arm is not completely extended, you will see a surge of current. If the current remains constant, the jaw is at its maximum reach.
5. Once the sensor is locked in place, it is recommended that you remove the hole lock power cable and control unit from the site. Without power, the hole lock will not be able to retract, and the sensor will be secure.

3.4.1 Disengaging the hole lock

To retract the jaw of the hole lock:

1. Tension the load bearing cable, to take up any slack.

2. Hold the switch on the hole lock control unit in the RETRACT JAW or – position. If using a deep-borehole control unit, also turn the dial until the built-in ammeter indicates 0.3 – 0.5 A. More current is drawn retracting the arm, because the motor is now working against the spring.
3. When the lock arm reaches its fully retracted position, the motors will automatically stop and the current will drop to zero. If using a deep-borehole unit, return the dial to zero.

Manual operation

If you prefer, you can operate the hole lock by applying voltages directly to the sensor.

- To extend the jaw, connect the Hole Lock Motor pin on the sensor (or on the breakout box's HCU or RECORDER connectors) to a +12 V power source, and the Hole Lock Motor Return pin to 0 V (ground).
- To retract the jaw, reverse the polarity so that the Hole Lock Motor Return pin is at +12 V and the Hole Lock Motor pin is at 0 V (ground).

3.5 The surge suppressor sonde

3TBs can optionally be provided with an extra sonde, combining a surge suppression system with a cable strain relief arm.

The surge suppressor sonde has the same connector as the instrument on its top face and a short, permanently attached cable extending from the bottom, which connects directly to the 3TB. Internal electronics provide a high degree of protection from damage cause by electrical surges, as can arise during, for example, a nearby electrical storm. A combination of gas discharge tubes, metal-oxide varistors, zener diodes, inductors and capacitors helps prevent electrical surges from reaching the instrument.

Note that no surge suppression systems can offer total protection, especially in the event of a strike by a lightning bolt within a few tens of metres of the installation.

The bottom of the surge suppressor sonde has a spring-loaded metal arm which performs the same function as the strain-relief unit. The arm swings out from the bottom of the sonde to wedge against the side of the borehole. This removes any strain in the load-bearing cable and prevents vibrations from the surface from being transmitted to the instrument.



3.6 Using Baffles

Baffles are a useful tool to prevent convection currents in the borehole from generating low-frequency oscillations.

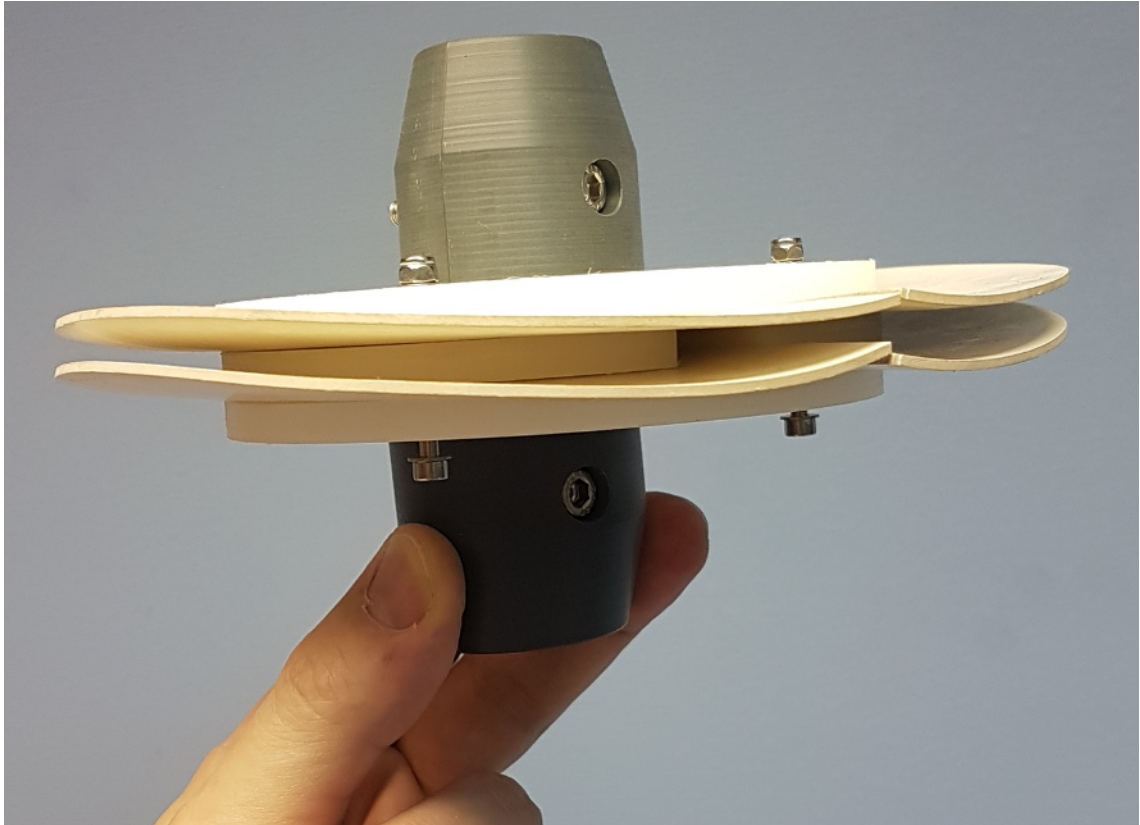

The baffle consists of some large, deformable washers and spacer material attached to a cable clamp. For best results, one should be installed on the signal & suspension cable, half way between the sensor and the surge arrestor. Once in position, it should be tightened onto the cable using the socket-head screws.

4 Installing the 3TB in a borehole

Before installing any instrument in a borehole, you should prepare the installation site.

- Clean the area around the borehole head, so there is clear access all around it.
- Keep the borehole capped at all times except when inserting or removing the instrument, so that debris and tools do not accidentally fall in.
- Lay out the cables beside the borehole, or set up a cable drum nearby, so that they do not become tangled.
- Ensure the tripod is tall enough to hang the entire installation (sensor and strain relief unit or digitizer) from it, with the sensor off the ground.
- Use a winch with a depth gauge if possible, or measure out the cable beforehand.

Most installations are equipped with a strain-relief unit, which consists of a metal arm that swings out from the load-bearing cable to wedge against the side of the borehole. This removes any strain in the load-bearing cable and prevents vibrations from the surface from being transmitted to the instrument.



Note: In installations with a down-hole digitizer, the strain-relief arm is fitted to the base of the digitizer sonde; the phrase “strain relief unit” in the following instructions should be taken to refer to the digitizer's strain relief arm.



Note: In installations with a surface digitiser, the strain-relief arm is built into the surge suppression sonde; the phrase “strain relief unit” in the following instructions should be taken to refer to the surge suppressor's strain relief arm.

4.1 Installing a sensor with hole lock unit

1. If your system has a separate surge-suppressor sonde, connect the captive cable from the surge-suppressor to the connector on top of the sensor and connect the signal cable to the top of the sensor. Otherwise, connect the signal cable directly to the connector on top of the sensor. Ensure that the “O”-rings inside the housing are clean and well greased. If necessary, apply a coat of extra silicon grease to the 'O'-rings – Dow Corning Molykote 111 is suitable. Tighten the knurled connector nut to its end stop. It may be necessary to wiggle the connector several times during tightening in order to ensure that the connector is screwed fully home.

2. If applicable, you should test the hole lock mechanism before installing the sensor. For safety reasons, the hole lock is normally supplied with the arm extended.

To test the mechanism, connect the signal cable to a breakout box and Hole-lock Control Unit and attempt to retract the hole lock arm (see Section 3.4 on page 17). If this fails, you should contact Güralp Systems. Extend the arm once more.



3. If your system does not have a separate surge-suppressor sonde, fix the main lifting cable to the shackle on top of the strain relief mechanism and run the signal cable through the mechanism using the built-in clamps (without tightening them). Otherwise, fix the main lifting cable to the shackle on top of the surge-suppressor sonde.



Caution: Do not allow the signal cable or the surge suppressor cable to bear any of the sensor's weight.

4. Attach the lifting loop to the sensor using four M5×16 screws (provided).



5. Join the loop to the bottom of the strain relief mechanism or surge-suppressor sonde using the linking cable provided.
6. Using a small winch, hoist up the sensor package and strain relief mechanism until both are hanging by the lifting cable, with the strain relief mechanism extended. If not using a separate surge-suppressor sonde, tighten the cable clamps on the strain relief unit, allowing a little slack in the signal cable.



7. Fix the signal cable to the main lifting cable about one metre above the strain relief mechanism using a cable clamp (a nylon cable tie may be sufficient for shallow installations). Leave a little slack in the signal cable between the clamp and the strain relief mechanism.
8. Position the assembly over the top of the borehole. Do not allow it to drag across the ground.

9. Lower the sonde so that its base is just level with the borehole mouth. If there is a depth gauge on the winch, set this to zero.
10. Continue to lower the sonde to a depth of about one metre, so that the instrument is still visible.
11. Extend the hole lock arm (see Section 3.4 on page 17) to check that it fits your borehole. The current drawn should dip slightly as the arm touches the casing, then drop to zero when it is fully extended. Check that the sonde is firmly anchored to the borehole casing by attempting to slacken the load bearing cable. If it remains taut, the sonde is still loose within the borehole. Do not proceed with installation in this case. Instead, you should either move the instrument to a narrower section of the borehole and try again, or contact Güralp Systems to fit a longer hole lock, quoting accurate measurements of your borehole.
12. Power up the instrument from a suitable power supply.
13. Level and centre the sensor (see Section 4.5 on page 39) so that it can be tested.
14. Check that the sensor is functioning correctly by connecting a meter or monitoring device to the sensor outputs. If the sensor fails to register ground movements, contact Güralp Systems.
15. Lock the sensor masses once more, tension the load bearing cable and retract the hole lock arm.
16. Gently lower the sensor to the required depth. At approximately 20-metre intervals, fix the signal cable to the load bearing cable using cable clamps (nylon cable ties every five metres may be sufficient for shallow installations). This will ensure that the signal cable does not become kinked or trapped within the borehole. Leave a little slack on the signal cable each time, so that it does not bear any weight. Too much slack, however, will cause the cable to scrape against the borehole casing.



17. Fix the sensor system into the borehole using the hole lock arm (see Section 3.4 on page 17).



Note: If you are installing a 3TB in a deep borehole, the weight of the sensor will stretch the load bearing cable slightly. Remember to allow for this when raising or lowering the cable in the following steps.

18. Use the winch to drag the assembly up within the borehole for a distance of 15 to 30 centimetres. This will ensure that the hole lock arm and the skids or studs on the sonde keep the sensor package vertical within the borehole. Do not drag too far, or you will damage the contact points.
19. Lower the load bearing cable by around 30 cm to engage the strain relief unit inside the borehole casing and to provide some slack in the cables.
20. Clamp the load bearing cable to the top of the borehole.
21. Tie the lifting and signal cables together above the strain relief mechanism using tie wraps.
22. The sensor can now be levelled and unlocked ready for use.

4.2 Installing a sensor using sand backfill

Dry sand backfill is a convenient and effective way of installing a borehole or post-hole sensor in a time-stable environment. The presence of sand not only fixes the sensor in place at the bottom of the hole, but also reduces noise due to air convection.

The ideal type of sand to use is the fine, kiln-dried sand used for children's play sandpits. This is readily available in airtight bags, is thoroughly washed and clean, and will contain little sediment. (When dried out after wetting, sand containing foreign matter may solidify and "concrete" the sensor in position.) This sand is suitable for use in both dry and damp boreholes.

In the procedure outlined below, the sensor rests on a pad of sand around 300 mm thick. This pad will absorb any residual moisture at the bottom of the borehole, and ensure that the surroundings of the instrument are kept dry.

After positioning the sensor, more sand is added to fill the space between it and the borehole casing, holding it firmly in place. The sand should reach within 30 mm of the top of the instrument, but should not cover it. This way, the instrument can be more easily recovered when it requires maintenance or replacement. This is particularly important if the borehole is not completely dry, since moist sand does not flow well.

The following photographs show the steps involved in backfilling with sand:

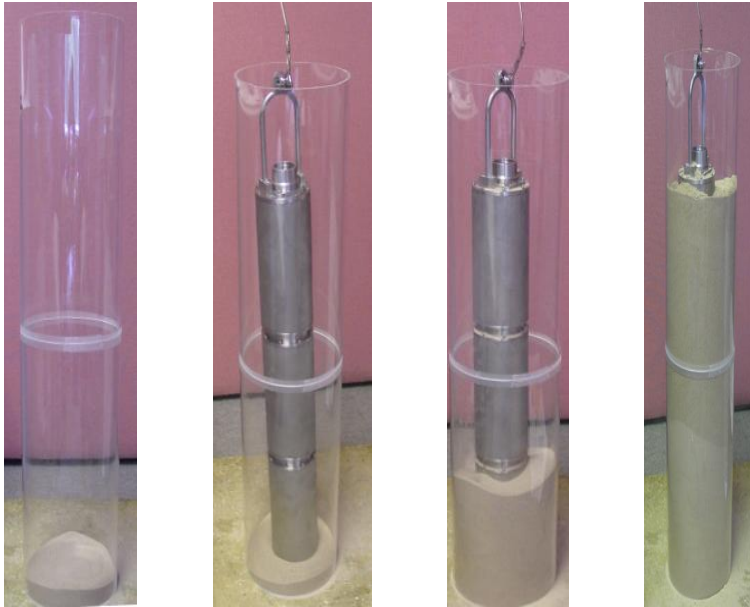

4.2.1 Procedure

To install a sensor at the bottom of a borehole of known depth using sand backfilling:

1. Measure or calculate the physical volume of the unit which is to be installed in the borehole. (The volume of a cylinder is given by $v = \pi r^2 h$.) Also measure the internal diameter of the borehole.
2. Measure and pour in a sufficient quantity of sand to fill the borehole to a depth of around 300 mm.
3. Connect the signal cable to the connector on top of the sensor. Ensure that the "O"-rings inside the housing are clean and well-greased. If necessary, apply a coat of extra silicon grease to the 'O'-rings: Dow Corning Molykote 111 is suitable. Tighten the knurled connector nut to its end stop. It may be necessary to wiggle the connector several



times during tightening in order to ensure that the connector is screwed fully home.

4. If your system does not have a separate surge-suppressor sonde, fix the main lifting cable to the shackle on top of the strain relief mechanism and run the signal cable through the mechanism using the built-in clamps (without tightening them). Otherwise, fix the main lifting cable to the shackle on top of the surge-suppressor sonde.



Caution: Do not allow the signal cable or the surge suppressor cable to bear any of the sensor's weight.

5. Attach the lifting loop to the sensor using four M5×16 screws (provided).



6. Join the loop to the bottom of the strain relief mechanism or surge-suppressor sonde using the linking cable provided.
7. Using a small winch, hoist up the sensor package and strain relief mechanism until both are hanging by the lifting cable, with the strain relief mechanism extended. If not using a separate surge-suppressor sonde, tighten the cable clamps on the strain relief unit, allowing a little slack in the signal cable.



8. Fix the signal cable to the main lifting cable about one meter above the strain relief mechanism using a cable clamp (a nylon cable tie may be sufficient for shallow installations). Leave a little slack in the signal cable between the clamp and the strain relief mechanism.
9. Position the assembly over the top of the borehole. Do not allow it to drag across the ground.
10. Lower the sensor so that its base is level with the borehole mouth. Set the depth gauge on the winch to zero.
11. If using a baffle, as described in section 3.6 on page 20, fit it now, half-way between the sonde and the strain-relief.
12. Calculate how much lifting cable must be lowered into the borehole, taking into account the length of the sensor and the strain relief assembly or digitizer.



Note: If you are installing a 3TB in a deep borehole, the weight of the sensor will stretch the load bearing cable slightly. Remember to allow for this when raising or lowering the cable in the following steps.

13. Begin lowering the sensor down the borehole, keeping track of the depth reached.

- At approximately 20-meter intervals, fix the signal cable to the load bearing cable using cable clamps (nylon cable ties every five metres may be sufficient for shallow installations). This will ensure that the signal cable does not become kinked or trapped within the borehole. Leave a little slack on the signal cable each time, so that it does not bear any weight. Too much slack, however, will cause the cable to scrape against the borehole casing.

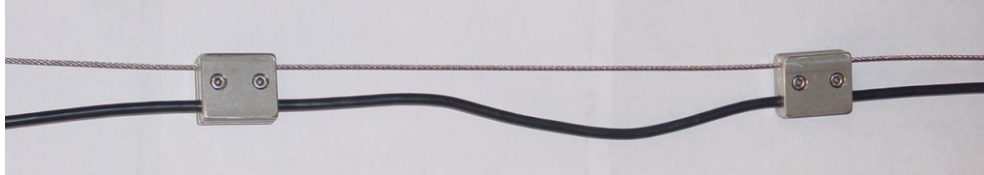

- Whilst monitoring the depth of the sensor, carefully approach the sand layer at the bottom of the borehole. The lifting cable will go slack when the sensor makes contact with the sand.



Note: If the lifting cable goes slack before the sensor has reached the sand layer, it may have become caught on a bad joint or lip in the borehole; carefully raise and lower the instrument to free it.

- When you have reached the bottom, use the winch to lift the package slightly, taking the slack off the cable. This ensures that the sensor is hanging vertically within the borehole, and is no longer in contact with the sand bed.

At this point, you may wish to use an inclinometer monitor unit to check that the instrument is sufficiently close to vertical to be properly centred. See Section 4.5 on page 39, for details.

- Calculate the volume of dry sand required to fill the gap between the sensor and the borehole liner to the level of the top of the sensor ($v = \pi r^2 h$ using the internal radius of the borehole, less the volume of the instrument determined in step 1).
- Pour this sand into the borehole. If you can, check how much of the sensor is covered with sand. GSL can provide bore-hole cameras with built-in illumination for this purpose. Do not overfill the hole.
- Carefully slacken the load bearing cable. This will engage the locking arm of the strain relief mechanism and secure the installation within the borehole.
- Without pulling or lifting the sensor, lightly shake the cables to remove any sand that may have fallen onto them or onto the strain relief mechanism.
- Clamp the load bearing cable to the top of the borehole, and remove the winch.
- The sensor can now be centred and unlocked ready for use.

4.3 Assembling the winch

If required, Güralp Systems can provide a winch suitable for installing a borehole sensor. The winch and tripod are supplied as a set of parts which you can assemble on site. The precise model supplied may vary so please use this section as a guide only and, if in doubt, contact Güralp System technical support (via an email to support@guralp.com) for advice.



There are two sections for each leg of the tripod. The upper sections are pre-attached to the head of the tripod; the lower sections are supplied detached.

1. Slide the lower sections all the way into the head with the retaining tape loops facing outwards.



2. If you are working on a surface of sand or soil, rotate the feet so that the points face downwards (left). For rock or other hard surfaces, ensure the pads face downwards (right).



3. Erect the tripod above the borehole, and run the yellow retaining tape through the loops. Fasten together the ends of the tape.



4. The lifting cable is supplied with a loop at one end. Run this over one of the pulleys at the top of the tripod, so that the loop hangs down between the legs. If the loop is not provided, you can make one by untwisting three outer strands from the (7-core) cable, crossing the two sets, and splicing the three outside strands back around the remaining four in the opposite direction. Secure the loop with a cable clamp.
5. If your tripod has two pulleys, run the sensor signal cable through the second pulley. Secure both cables in their pulleys by sliding the attached bolts into place. For tripods with a single pulley, the sensor signal cable should not be routed over the pulley: it should pass between the legs and over the yellow tape, directly into the borehole mouth.

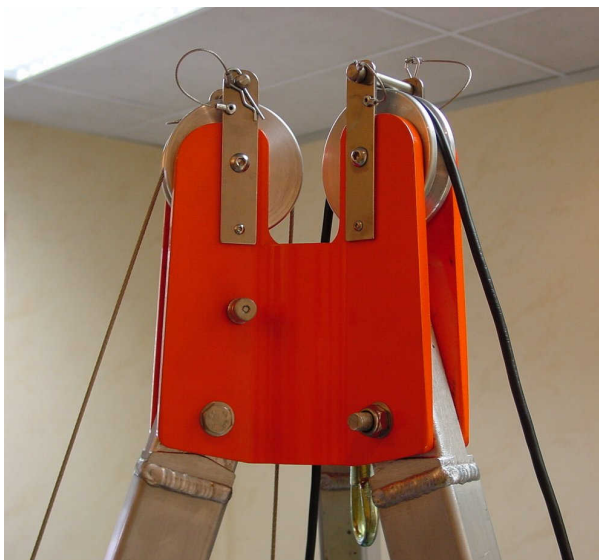

6. Extend each of the three legs in turn to the height you require, leaving the leg with the winch attached until last.



7. Take the end of the load-bearing cable without the loop, and screw it to the axle inside the winch using a 4 mm hexagonal key (provided) as shown.

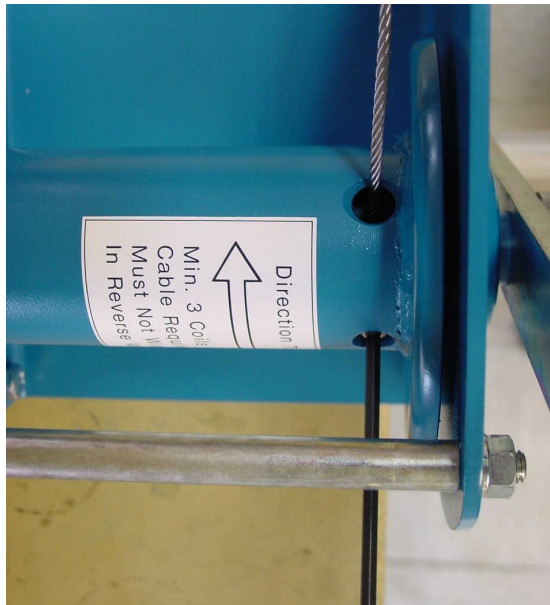

8. Attach the handle to the side of the winch **opposite** the ratchet mechanism, and fasten it in place with a collar, washer and screw, using the larger hexagonal key.

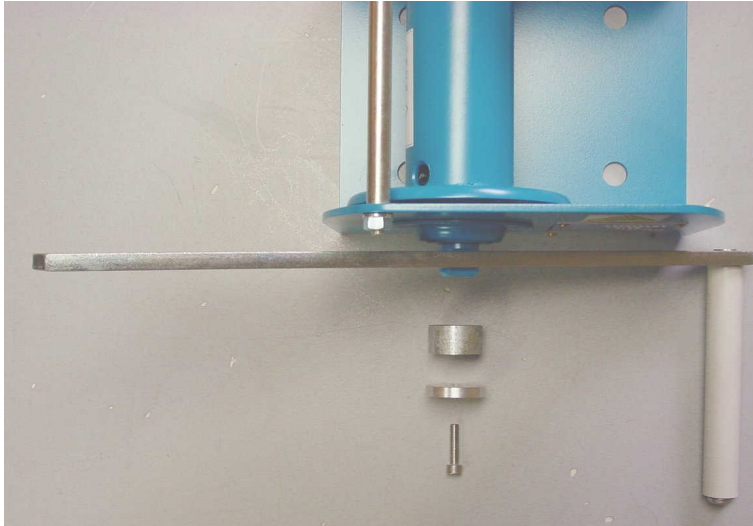

9. Wind the cable onto the winch by rotating the handle. Ensure that the cable builds up neatly across the drum. Continue winding until the loop on the other end is as high as you need it to install the equipment.

If the ratchet prevents you from winding the cable on, twist the metal boss in the DOWN direction to free the cable.



10. Remove the handle, and screw it onto the metal spool of the ratchet mechanism.

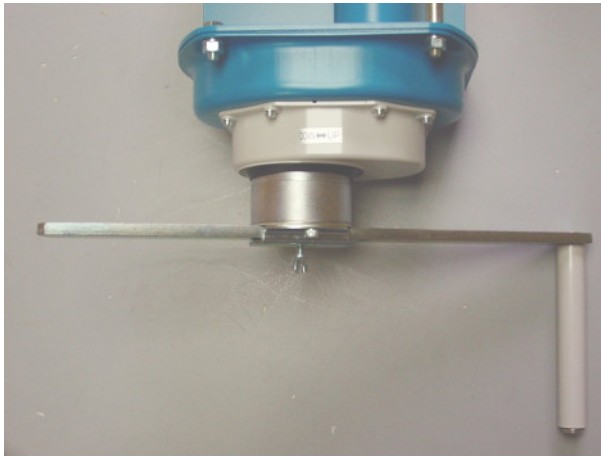

11. Hang the strain relief unit and instrument(s) from the loop at the other end of the cable. You are now ready to lower the assembly into the borehole as described above.
-

4.4 Earthing a borehole sensor

To achieve the best performance from any borehole instrument, you must make sure that the sensor electronics, its casing and the power supply share a common, local ground, and that all power and data lines are adequately protected against lightning and other transients.

This section describes techniques for grounding sensor equipment which have proved effective in many installations. However, local conditions are always paramount, and you should design your installation with these in mind. Any regulations in force at your chosen location must also be followed.

4.4.1 Installations with AC power supplies

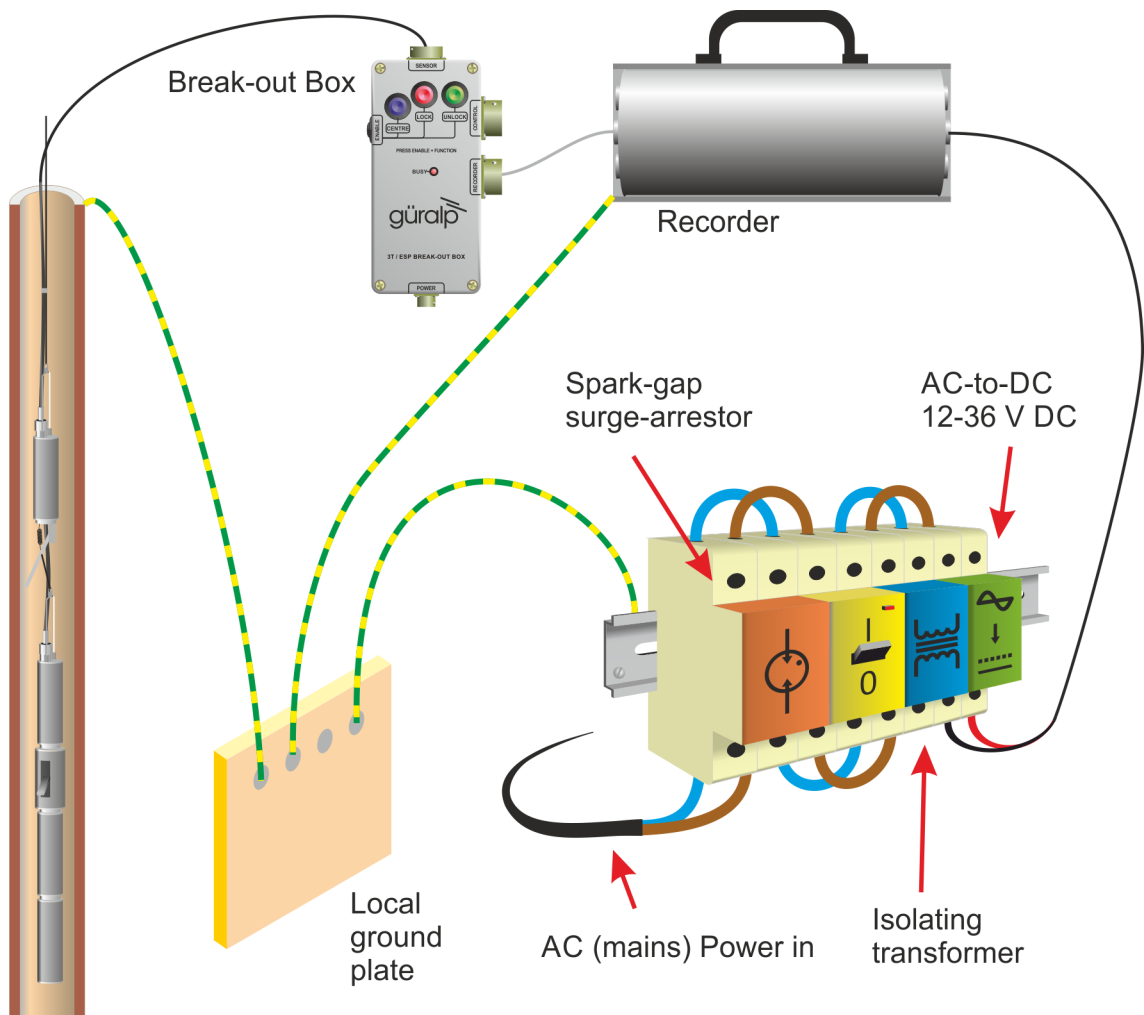

If you are using mains (outlet) power, or some other AC power distribution system, we recommend installing a fully isolating transformer between it and the power supply for the instrument. This will allow full control of the local ground.

A spark-gap surge protector should also be installed on the mains side of the transformer, so that transient over-voltages are not transmitted across it. Suitable protectors are available off the shelf from several suppliers. On the sensor side, surge protection is installed as standard within all new Güralp borehole sensors and control equipment. If your surface installation includes third party electronics, digitizers, etc., you may need to install additional protection where power and data lines enter the surface enclosure. Contact Güralp Systems if you are unsure.

Within the installation, a single ground point should be established, which is connected to a local ground plate. All earth lines for equipment in the installation, such as the casings of the transformers and of the sensor electronics, as well as the signal ground line from the sensor, should be connected to this plate.

The best local earth point in many installations is the borehole itself. For this to work, the borehole must have a conductive casing and be situated close (<30 m) to the surface installation. In such an installation you need only connect a cable (green wire in the photograph below) from the local ground plate to the borehole casing.



An earth strap can be used to ensure a good connection.

If the lower borehole is filled with salt water, the instrument will be adequately grounded without any further action. Fresh water is an inferior conductor.

In a dry or sand-filled borehole, or one with a non-conducting casing, you will need to ensure the sonde is grounded by some other means. The best option is often to attach the sensor housing to an earth line brought out to the surface and attached to a metal stake driven into the ground nearby.

The sensor's load bearing cable is suitable for this purpose, provided it is secured to the sensor's lifting loop with a metallic clamp as shown below. This provides an additional firm electrical contact between the sonde and the load-bearing cable.

If your system has a separate surge-suppressor sonde, this technique should be used to ground the load-bearing cable to the surge-suppressor. A separate grounding cable must then be provided between the surge-suppressor and the sensor. The short, intermediate load-bearing cable between the two units can be used for this purpose.

Installations with down-hole digitizers will need similar arrangements at the top and bottom of the digitizer module, or a separate cable for this purpose.

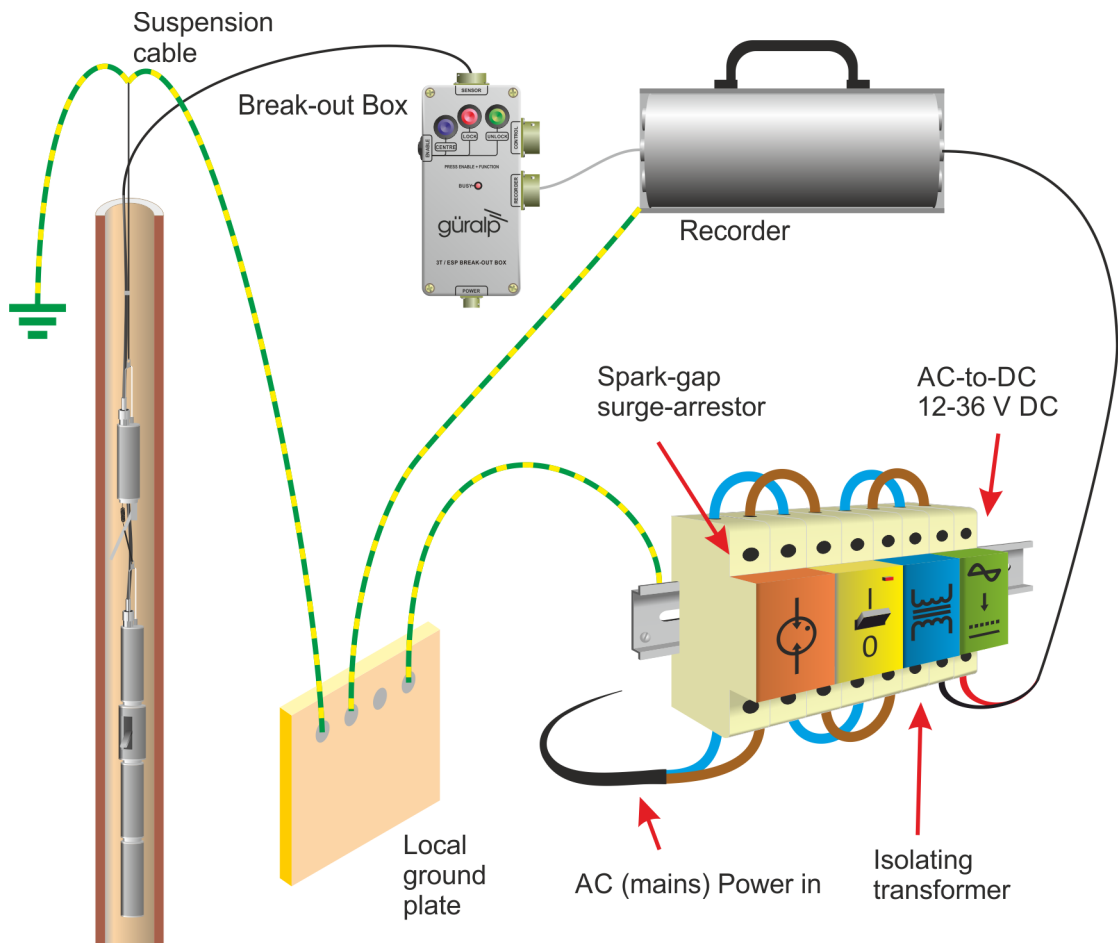

For boreholes with a metallic casing at the bottom and plastic above, we recommend connecting a cable between the sensor housing and the ground plate so that the lower borehole casing acts as the earthing point.

If there is a significant distance (>30 metres) between the borehole and the surface installation, the resistance of the earth cable may make it impractical to use the borehole as an earthing point. In these cases, you will have to connect the local ground plate to an earth stake near to the enclosure; any coupling between this sensor-local earth line and ground lines for other parts of the system must be minimized.

4.4.2 Installations with DC power supplies

Güralp sensors require a 12 to 36 V DC power supply. In most cases, this is provided by an isolating DC/DC converter installed at the surface. This converter can be earthed to the local ground plate as above.

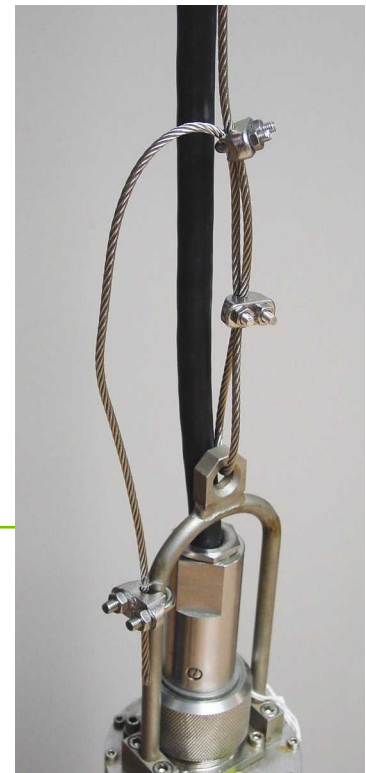

However, DC/DC converters contain sensitive electronics, which must be protected thoroughly. We recommend installing a full surge protection unit in addition to the spark gap protector. This protection is installed on the supply side of the isolator, so it must be earthed separately from the borehole installation. Otherwise, transients in the power supply will couple to the sensor.

As with AC installations, if the borehole is more than around thirty metres from the surface enclosure, you will need to provide a second earthing point for the local ground plate.

DC power is most commonly available at self-contained installations with power supplied from batteries, solar panels, or a wind generator. In these cases, the power supply may already have protection from transients installed, in which case you may not need such comprehensive protection (although some form of protection is always necessary.)

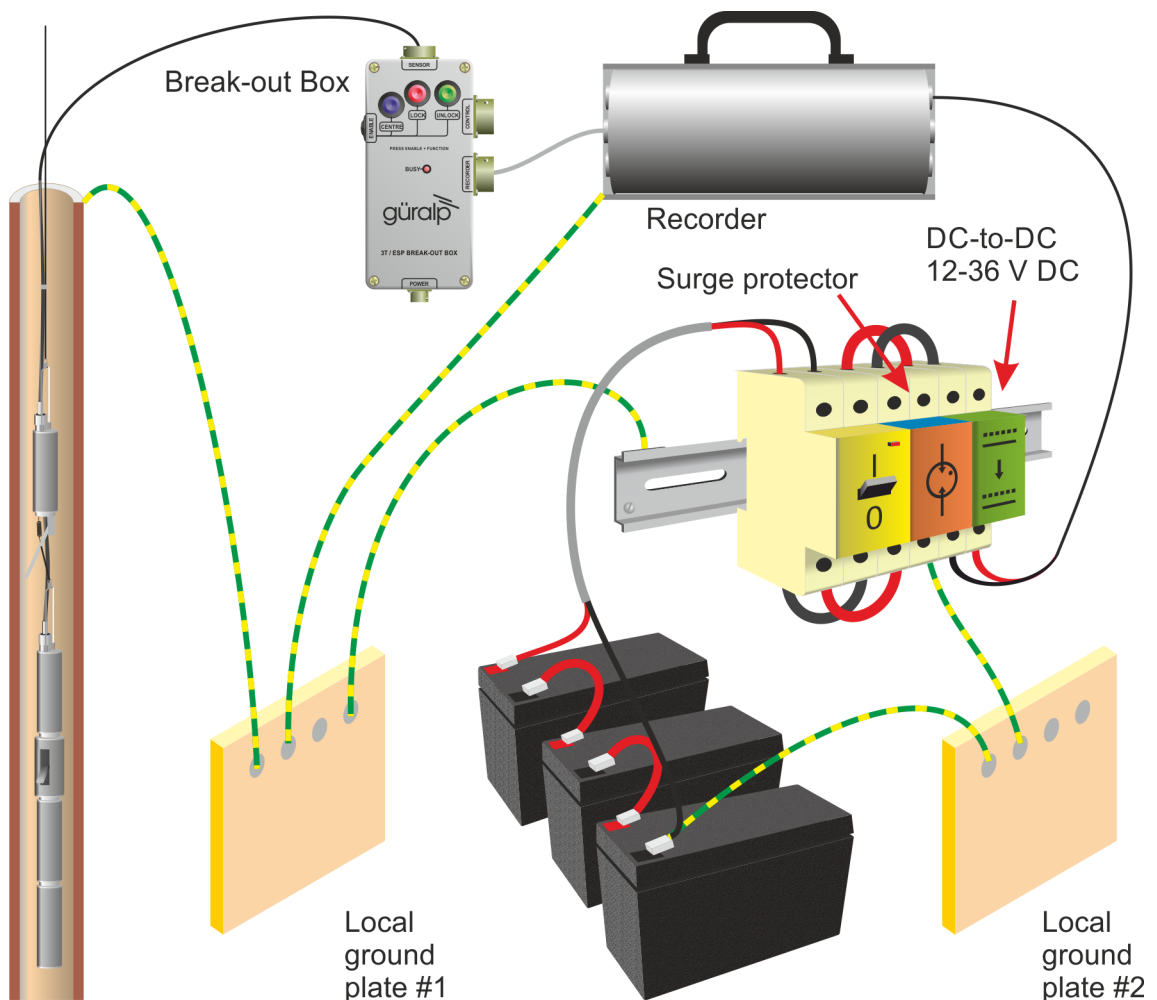

4.4.3 External lightning protection

The surface installation building and, if possible, the borehole should both be protected by lightning conductors.

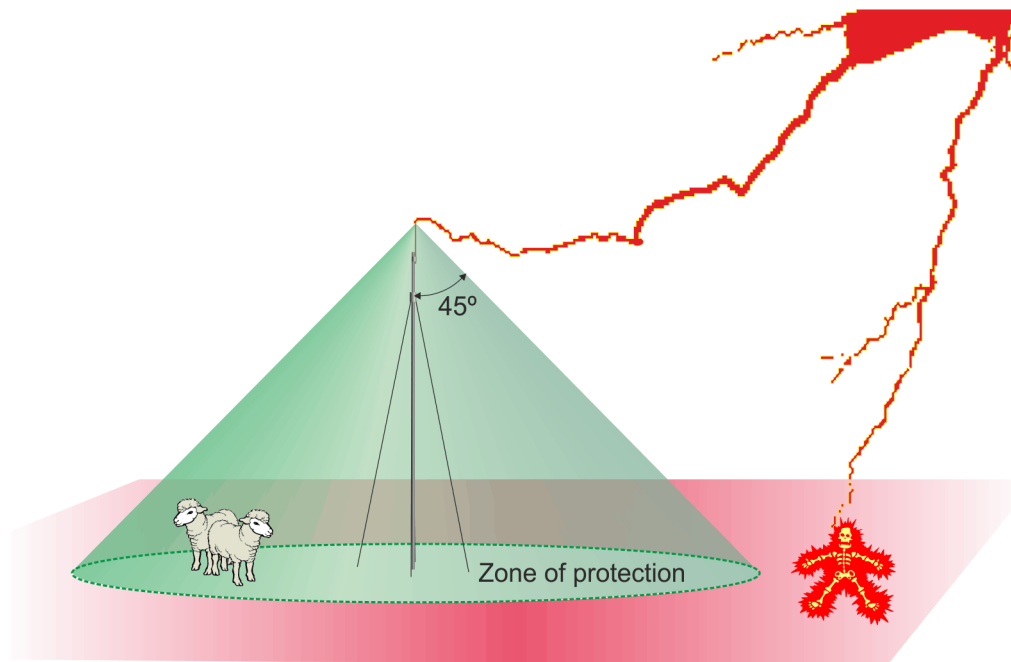

These should lead to grounding point well away from the borehole. As a rule of thumb, a lightning mast provides a "zone of protection" within a 45° cone descending from the top of the mast.

If you are using two earthing points, for example in the DC installation shown above, it may be convenient to connect the lightning conductor to the supply-side earthing point. In any case, the lightning earth must be well separated from the borehole (and its earth, if it needs one.)

4.5 Levelling and Centring

Once it is installed, you should level and centre the instrument ready for use. This can be done using the various surface control units:

1. Connect an inclinometer monitor unit to the breakout box.
2. Turn on the borehole control unit using the ON/OFF switch under the transparent flap.
3. Turn on the inclinometer monitor unit using its ON/OFF switch, and read off the X and Y components of the tilt from the analogue meters.
4. If both tilts are within the green shaded region, the instrument is close enough to vertical that it can be levelled and centred successfully. If either

output is in the red shaded region, you should not attempt to unlock or centre the sensor masses. Instead, if possible, you should move the instrument within the borehole to a place where it can lie closer to vertical.

5. Connect a hand-held control unit (HCU) to the sensor control unit, if you have one.
6. Unlock the sensor masses, either by pushing the UNLOCK buttons of the borehole control unit, or by holding down the ENABLE and UNLOCK switches of the HCU together for at least six seconds.
7. When you press the switches, the BUSY LED will come on. After a while, the unlocking process will be completed, and the instrument will start centring itself. Whilst this happens, the BUSY LED will flash.
8. Monitor the outputs of the mass positions, either using the HCU or your recording system. The microcontroller inside the unit will zero the outputs from the vertical, N/S and E/W sensors in sequence. After successful centring, the mass position outputs should be in the range 0.1 – 0.8 V.
9. If the centring process leaves the mass position outputs above ± 1.1 V, repeat steps 4 and 5. You will probably need to initiate the centring process several times before the masses are adequately centred.

4.6 Down-hole orientation

Once the sensor is installed inside the borehole, you will need to measure its orientation with respect to True North or Magnetic North. There is no need to rotate the sensor itself, since the data can be rotated algorithmically after it is digitised.



Note: The most common problem affecting sensor orientation is the difficulty of determining an accurate North at the installation site. Local variations in the Earth's magnetic field affect magnetic compasses, as do many local structures, including including the metal bore-hole casing itself.

A simple method for determining the orientation of a sensor package using the sensor's own horizontal component sensors, has been used effectively by the Blacknest Seismological Centre, UK, with down-hole and surface equipment from Güralp Systems (*AWE Report O 10/93, 1993*.)

In this experiment, signals received by the N/S component of the reference sensor are correlated with those received at the N/S and E/W components of the sensor being studied, after different amounts of mathematical rotation. The highest correlation will occur when the N/S component of the reference sensor matches the rotated N/S component of the borehole sensor.

Once you know the deviation of the borehole components, you can instruct the digitizer to rotate the signals algorithmically.

4.6.1 Installing the Scream! extension

The *Relative Orientation* extension is supplied in the standard Windows distribution of Scream.

The extension uses Matlab libraries, which are currently only available for Windows. However, you do not need the full Matlab package to use the extension. The Matlab runtime libraries are installed as part of the Scream! distribution.

4.6.2 Installing the reference instrument

To measure the orientation of a sensor, you will need a second instrument which is known to point precisely North. We recommend the use of a Güralp H3, a single-component horizontal instrument with an elongated "North" pointer. This is supplied as part of our Borehole Orientation Kit. The instrument should be located on a solid surface as close to the other instrument as possible. Most boreholes are constructed with a concrete base around the top of the borehole; if this is present, we recommend installing the reference sensor there. A good coupling to bedrock is, however, more important than proximity so, if there is a nearby seismic vault or basement, you may get better results installing the reference sensor there.

Ideally, the two sensors will be directly connected to the same 6-channel digitizer.



Note: If you are using separate digitizers, you will need to ensure they are exactly synchronized. This can be done by connecting GPS receivers to both digitizers and waiting for the control system of each one to settle. This process takes at least 12 hours.

Record at least an hour and, ideally, 24 hours of data from both the reference sensor and the borehole sensor. Try to pick a period when local, cultural noise is at a minimum: the procedure works best with teleseismic data.

4.6.3 Measuring the orientation

1. Open the recorded files in Scream!. Under Windows, double-click on the .gcf files in Explorer. Under Linux, you can double-click on the files in Nautilus, Nemo etc if you have configured your system this way or, from the command line, you can run

```
scream --view path_to_.gcf_file...
```

A WaveView window will open displaying your recorded streams:

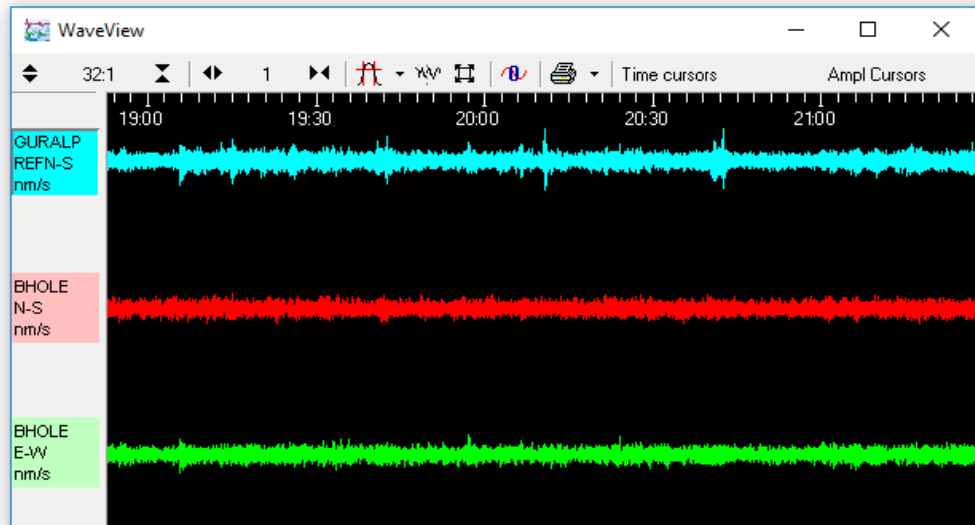

2. Drag the streams across the window so that the reference stream is at the top, the N stream in the middle, and the E stream at the bottom.
3. Locate a suitable data range. A good range would contain lots of teleseismic events and very little local noise. You should use a period of at least an hour, and preferably much longer.
4. Hold down  and drag across the WaveView window with the left mouse button until all three streams are selected for the whole range. Make sure there are no gaps in the data you select. If gaps are present in any streams, the selection for those streams will be shown with hatched lines to alert you:

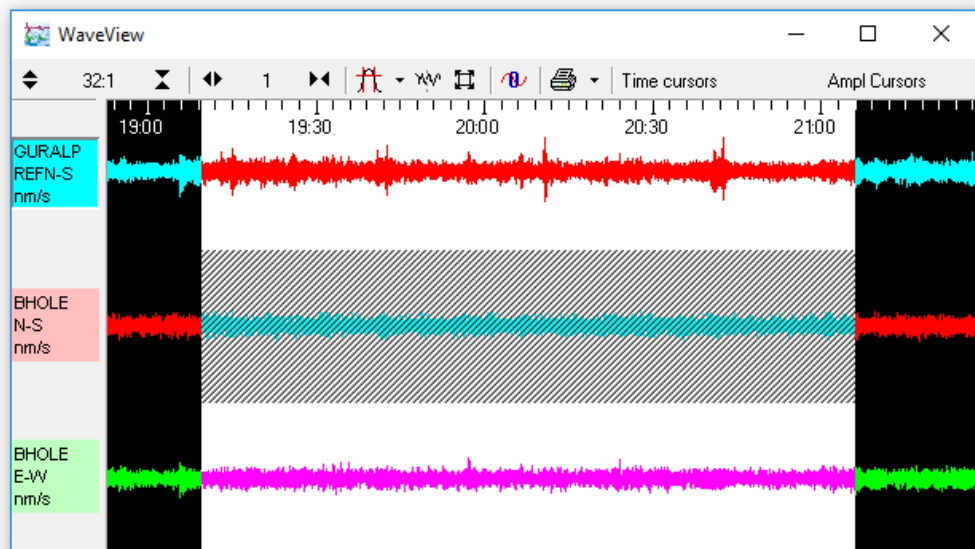

When you are happy with the selection, release the mouse button, but keep  held down.

- When the context menu appears, release  and select Relative Orientation from the menu:

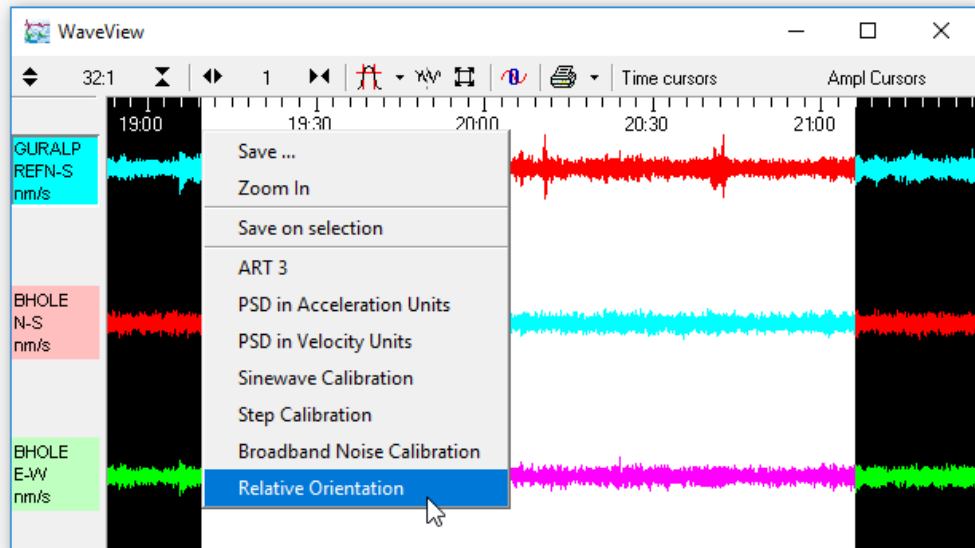

Two small windows will appear: a progress window:

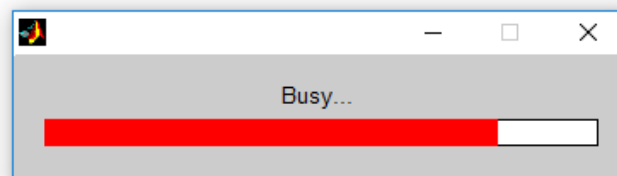

and, typically, a warning like:

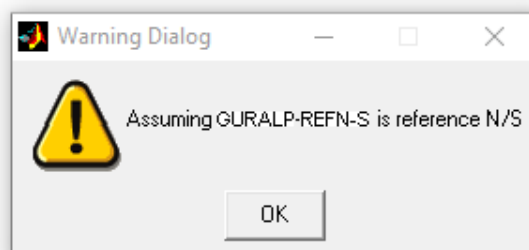

Scream! produces this warning when the reference sensor is not using a standard N/S channel, *i.e.* it is using the auxiliary (X) channel instead. If you are using a separate digitiser, the warning will not appear.

If you see a different error message, make sure that the streams are in the correct order in the WaveView window. If you still have problems, you may have selected too few data points for it to be confident about the orientation; you should try again with a larger selection.

6. After a few seconds, the calculation should finish and three windows will appear. (They may obscure each other.) The top window is a graph of Coherence vs Angle:

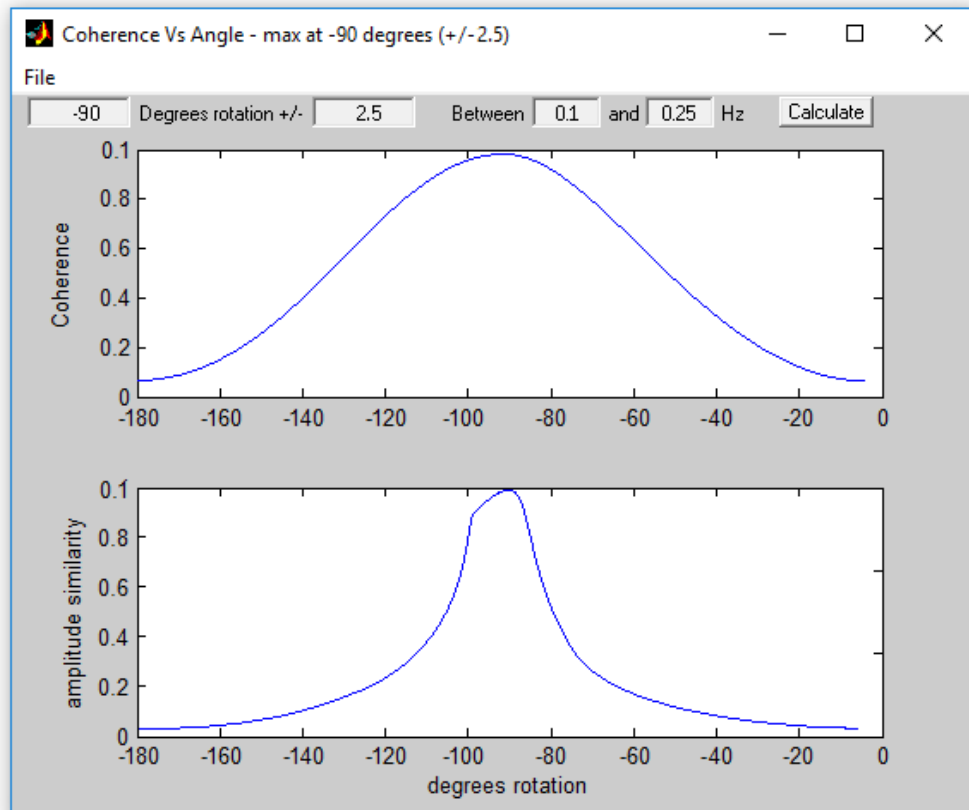

The two-stage algorithm rotates the N/S and E/W components of the sensor being tested in small steps. It measures first the amplitude similarity, and then the coherence between the virtual (rotated) N/S component and the reference N/S component, for a number of rotation angles.

The error in the final calculation is around 2.5°.

The peak of the coherence curve (upper graph) therefore corresponds to the angle of rotation which best matched the reference component. This angle is shown in the title bar, together with an estimated error.

You should see a coherence curve which is smooth and symmetrical. If the curve is distorted, either the surface data are too noisy or the data selection is too short.

The lower graph shows the overall amplitude similarity of the rotated signal. This provides an idea of the sign of the coherence (since signals in perfect antiphase have a high coherence as well as those in phase). If there are two peaks in the coherence graph, the correct one is where the amplitude similarity is most positive.

The sample plots show that the borehole instrument is installed with its N/S axis at a bearing of -90° from true North.

- The second window shows the result of applying the rotation to the signal, *i.e.* the time series that a sensor in perfect N/S orientation would have produced:

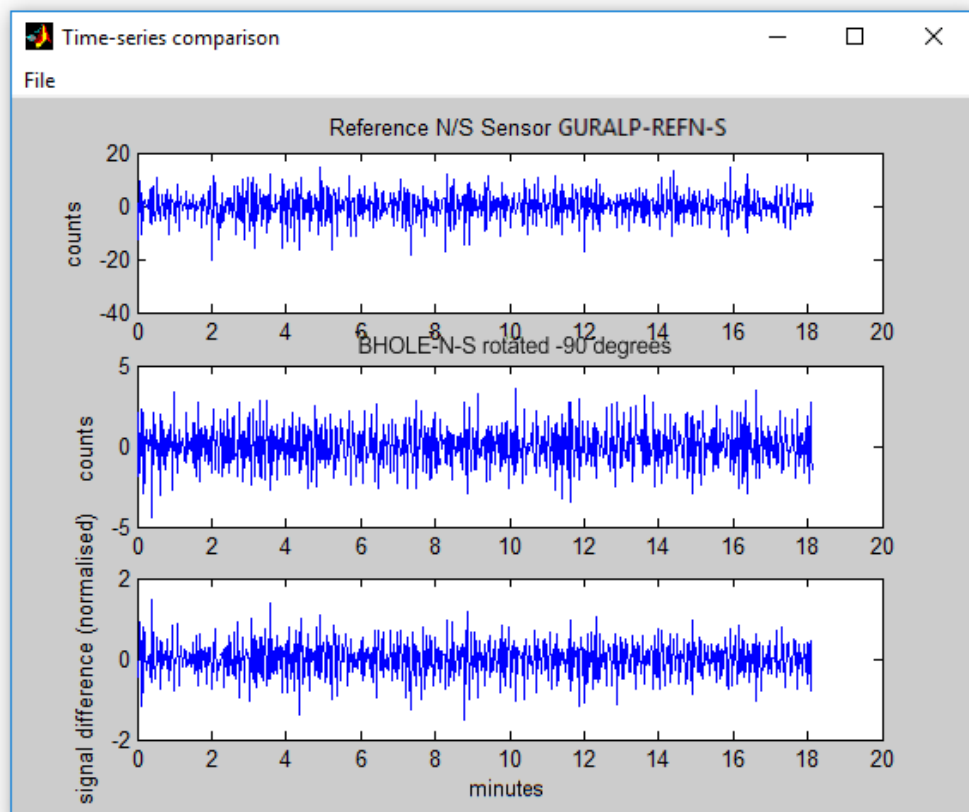

- You can perform more accurate calculations by narrowing the search range. This is done in the two left-hand-side entry boxes on the Coherence vs Angle window: the first denotes the centre of the new search and the second specifies its range. The program suggests suitable values for you, so in most cases you can just click to perform another iteration.

9. A new graph will be displayed showing the results:

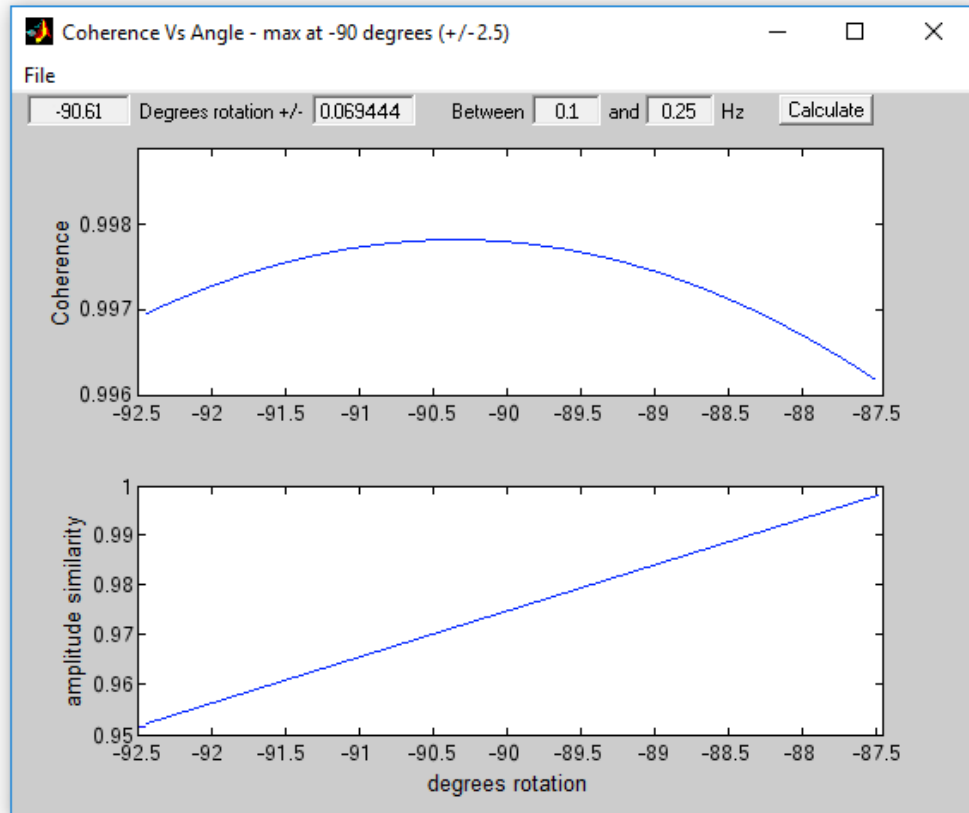

Our sample instrument is thus aligned at $-90.61 \pm 0.07^\circ$.

10. The error given is only a rough estimate. For best results, you should repeat the orientation experiment several times using different data sets. The true error in the computed orientation can then be determined by observing the spread of the results.

The Blacknest orientation method generally provides a reliable indication of the sensor's orientation. In most cases, the greatest source of error is in the installation of the reference sensor.

If you have particular difficulty in deriving a stable value, additional information is contained in a third output window, which shows a waterfall plot of Coherence vs Frequency vs Angle. The frequency range used in the calculations is indicated with a black outline.

This plot can be used to select a more advantageous frequency range where the coherence curve is smoother and easier to interpret. In the example above, the frequency range 0.23 to 0.6 Hertz looks particularly promising: the surface within this range forms a smooth, symmetrical arch. Ideally, the peak should be very close to unity and the lowest points, at the margins, should be close to zero.

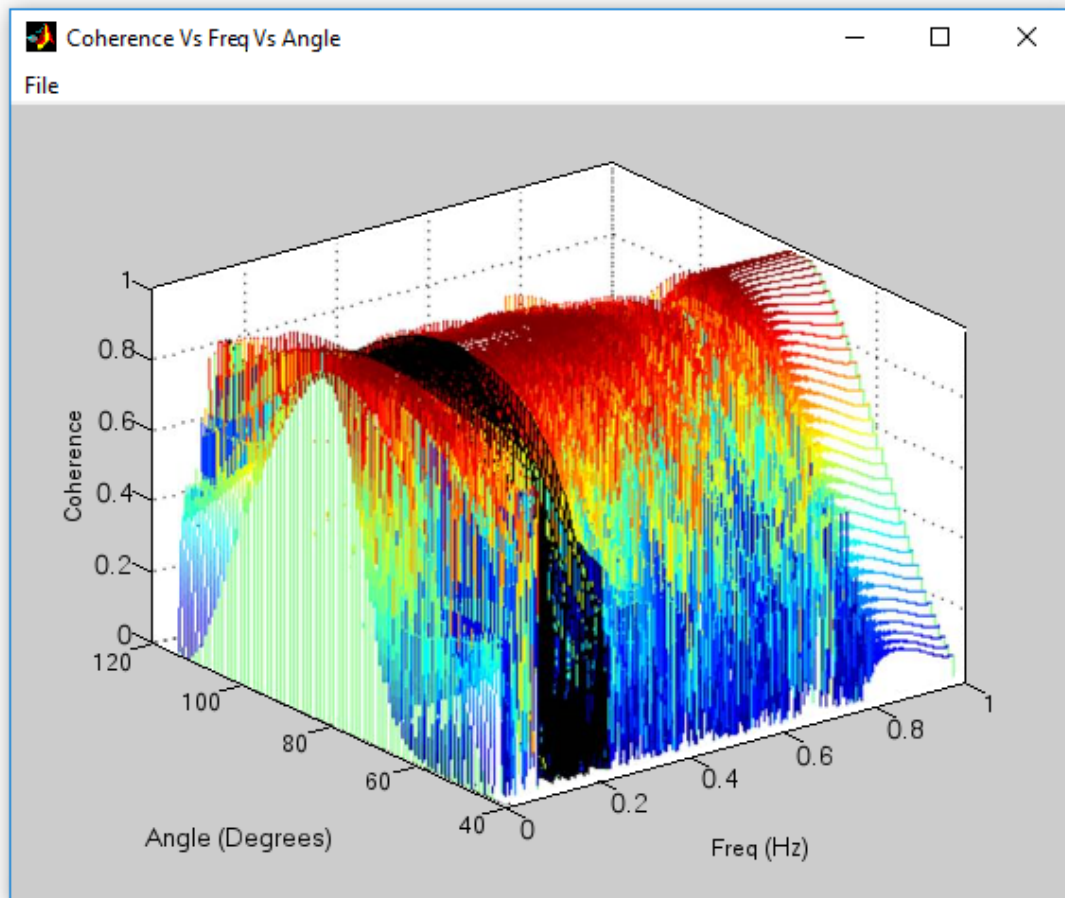

The chosen frequency range can then be entered into the Between X and Y Hz boxes at the top of the Coherence vs Angle window before clicking again; the data will be filtered accordingly before the coherence is recalculated, increasing the accuracy of the result.

4.6.4 Applying automatic rotation

You can configure a DM24 mk3 digitizer to apply an automatic rotation to the digitized data and output streams representing ground motion on true North/South and East/West axes.

This is done within the DSP to minimize the reduction in data quality.

To set up the rotation:

1. Open a terminal session with the digitizer. You can do this with a program such as `minicom` (for Linux) or `hyperterm` (for Microsoft Windows). Alternatively, you can access the digitizer's console through Scream! by right-clicking on its icon and selecting **Terminal...**

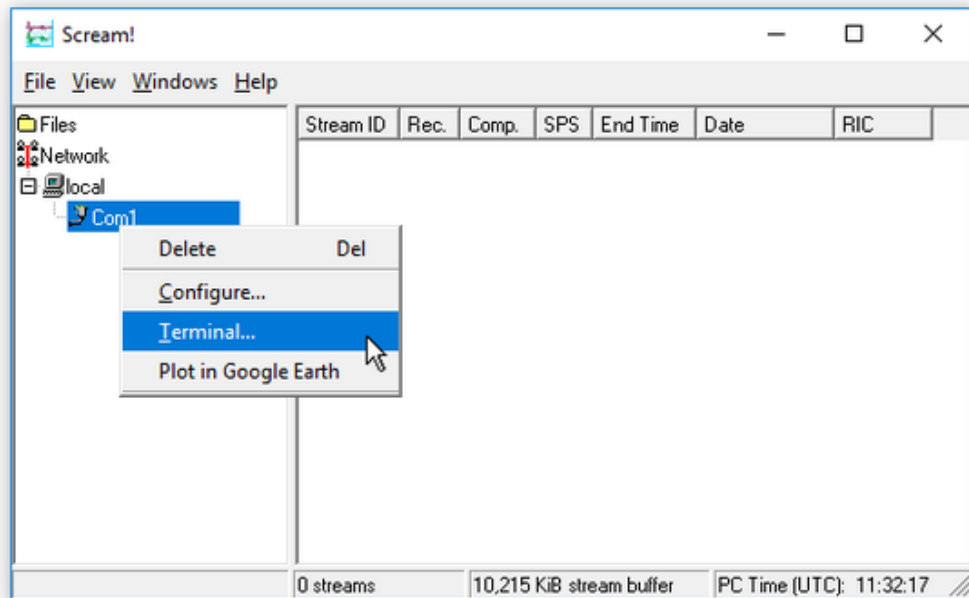

You should see an `ok` prompt, indicating that the digitizer is ready to receive commands:

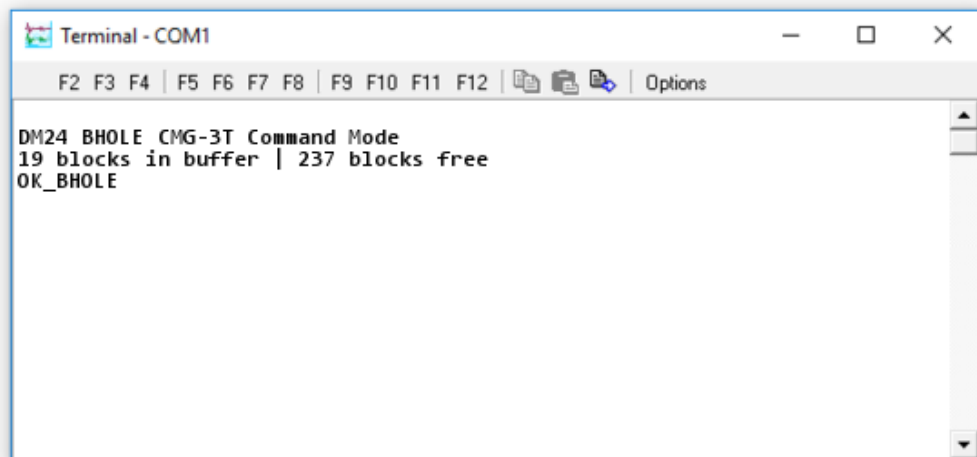

2. Type

`0 rotation AZIMUTH`

where *rotation* is the angle of deviation from true North that you measured earlier, as a whole number of tenths of a degree. This is the same angle (with the same sign) as that given by the orientation program.

The `0` tells the digitizer to apply the rotation to instrument number 0 (the first, or only instrument.)

Thus in the example above, you would type `0 -903 AZIMUTH` to make the digitizer rotate signals by -90.3 degrees.

3. Reboot the digitizer with the command `re-boot`.
4. Collect some more data with the transformation active, and carry out another orientation calculation. The data from the down-hole instrument should now have a maximum coherence with the reference sensor at 0 °. Check in particular that the sign of the rotation you have applied is correct.

5 Calibrating the 3TB

5.1 The calibration pack

All Güralp sensors are fully calibrated before they leave the factory. Both absolute and relative calibration calculations are carried out. The results are given in the calibration pack supplied with each instrument:

- *Works Order* : The Güralp factory order number including the instrument, used internally to file details of the sensor's manufacture.
- *Serial Number* : The serial number of the instrument
- *Date* : The date the instrument was tested at the factory.
- *Tested By* : The name of the testing engineer.

There follows a table showing important calibration information for each component of the instrument, *VERTICAL*, *NORTH/SOUTH*, and *EAST/WEST*. Each row details:

- *Velocity Output (Differential)* : The sensitivity of each component to velocity at 1 Hz, in volts per m/s. Because the 3TB uses balanced differential outputs, the signal strength as measured between the +ve and -ve lines will be twice the true sensitivity of the instrument. To remind you of this, the sensitivities are given as $2 \times$ (single-ended sensitivity) in each case.
 - *Mass Position Output* : The sensitivity of the mass position outputs to acceleration, in volts per ms^{-2} . These outputs are single-ended and referenced to signal ground.
 - *Feedback Coil Constant* : A constant describing the characteristics of the feedback system. You will need this constant, given in amperes per ms^{-2} , if you want to perform your own calibration calculations (see below.)
 - *Power Consumption* : The average power consumption of the sensor during testing, given in amperes and assuming a 12 Volt supply.
 - *Calibration Resistor* : The value of the resistor in the calibration circuit. You will need this value if you want to perform your own calibration calculations (see below.)
-

5.1.1 Poles and zeroes

Most users of seismometers find it convenient to consider the sensor as a "black box", which produces an output signal V from a measured input x . So long as the relationship between V and x is known, the details of the internal mechanics and electronics can be disregarded.

This relationship, given in terms of the Laplace variable s , takes the form

$$(V/x)(s) = G \times A \times H(s)$$

In this equation

- G is the acceleration output sensitivity (gain constant) of the instrument. This relates the actual output to the desired input over the flat portion of the frequency response.
- A is a constant which is evaluated so that $A \times H(s)$ is dimensionless and has a value of 1 over the flat portion of the frequency response. In practice, it is possible to design a system transfer function with a very wide-range flat frequency response.

The normalising constant A is calculated at a normalising frequency value $f_m = 1$ Hz, with $s = j f_m$, where $j = \sqrt{-1}$.

- $H(s)$ is the transfer function of the sensor, which can be expressed in factored form:

$$H(s) = N \frac{\prod_{i=1,n} s - Z_i}{\prod_{j=1,m} s - P_j}$$

In this equation z_n are the roots of the numerator polynomial, giving the zeros of the transfer function, and p_m are the roots of the denominator polynomial giving the poles of the transfer function.

In the calibration pack, G is the sensitivity given for each component on the first page, whilst the roots z_n and p_m , together with the normalising factor A , are given in the *Poles and Zeros* table. The poles and zeros given are measured directly at Güralp Systems' factory using a spectrum analyser. Transfer functions for the vertical and horizontal sensors may be provided separately.

5.1.2 Frequency response curves

The frequency response of each component of the 3TB is described in the normalised amplitude and phase plots provided. The response is measured at low and high frequencies in two separate experiments. Each plot marks the low-frequency and high-frequency cut-off values (also known as -3 dB or half-power points).

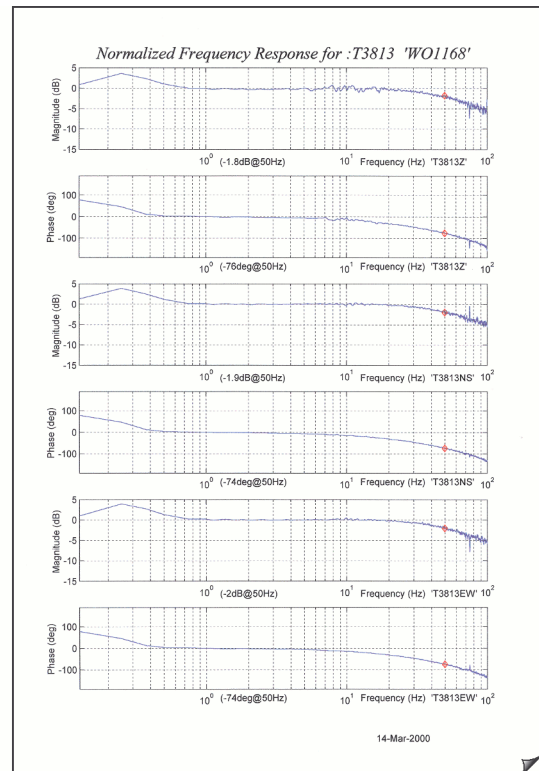
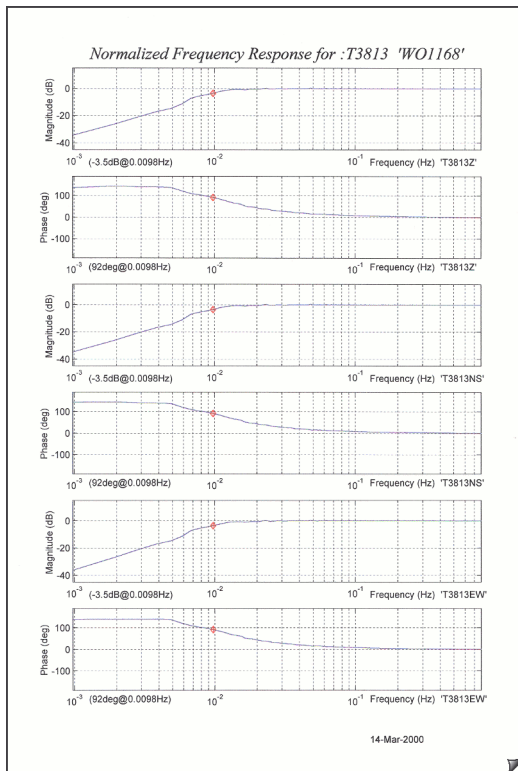

If you want to repeat the calibration to obtain more precise values at a frequency of interest, or to check that a sensor is still functioning correctly, you can inject calibration signals into the system using a Güralp digitizer or your own signal generator, and record the instrument's response.

5.1.3 Obtaining copies of the calibration pack

Our servers keep copies of all calibration data that we send out. In the event that the calibration information becomes separated from the instrument, you can obtain all the information using our free e-mail service. Simply e-mail caldoc@guralp.com with the serial number of the instrument in the subject line, *e.g.*

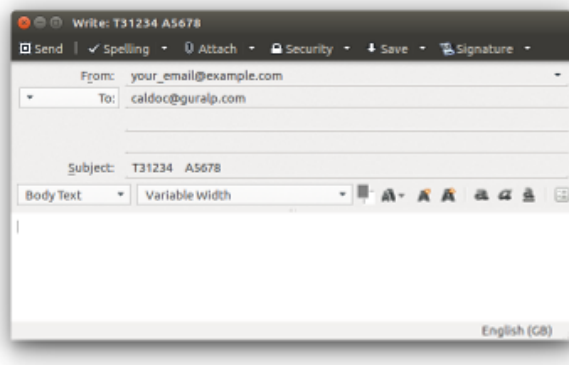

The server will reply with the calibration documentation in Word format. The body of your e-mail will be ignored.

5.2 Calibration methods

Velocity sensors such as the 3TB are not sensitive to constant DC levels, either as a result of their design or because of an interposed high-pass filter. Instead, three common calibration techniques are used.

- Injecting a step current allows the system response to be determined in the time domain. The amplitude and phase response can then be calculated using a Fourier transform. Because the input signal has predominantly low-frequency components, this method generally gives poor results. However, it is simple enough to be performed daily.
- Injecting a sinusoidal current of known amplitude and frequency allows the system response to be determined at a spot frequency. However, before the calibration measurement can be made the system must be allowed to reach a steady state; for low frequencies, this may take a long time. In addition, several measurements must be made to determine the response over the full frequency spectrum.
- Injecting white noise into the calibration coil gives the response of the whole system, which can be measured using a spectrum analyser.

You can perform calibration either using a Güralp DM24 digitizer, which can generate step and sinusoidal calibration signals, or by feeding your own signals into the instrument through a hand-held control unit.

Before you can calibrate the instrument, its calibration relays need to be activated by pulling low the *CAL ENABLE* line on the instrument's connector for the component you wish to calibrate. Once enabled, a calibration signal provided across the *CAL SIGNAL* and *SIGNAL GROUND* lines will be routed through the feedback system. You can then measure the signal's equivalent velocity on the sensor's output lines. Güralp Handheld Control Units provide a switch for activating the *CAL ENABLE* line. This is most easily done using Scream, as described in the next chapter.



Note: Unlike surface 3T instruments, the 3TB has only one calibration enable line for all components.

5.3 Calibration with Scream!

Güralp digitizers provide calibration signal generators to help you set up your sensors. Calibration is most easily done through a PC running Güralp's Scream! software.

Depending on the digitizer type, sine-wave, step and broadband noise signal generators may be available. In this section, broadband noise calibration will be used to determine the complete sensor response in one action. Please refer to the digitizer's manual for information on other calibration methods.

1. In Scream!'s main window, right-click on the digitizer's icon and select **Control...** Open the *Calibration* pane.

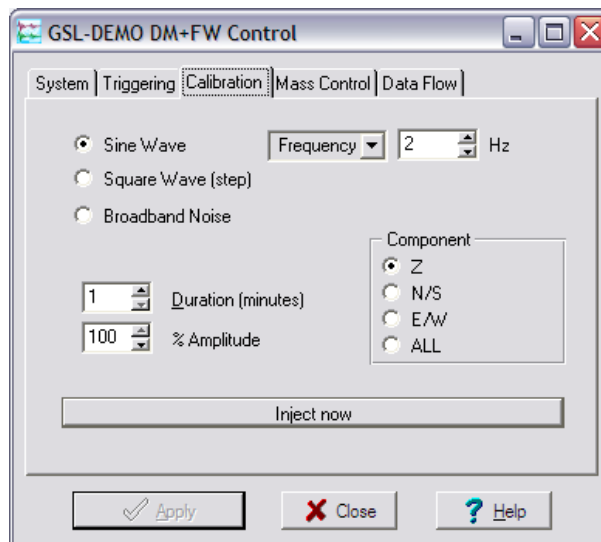

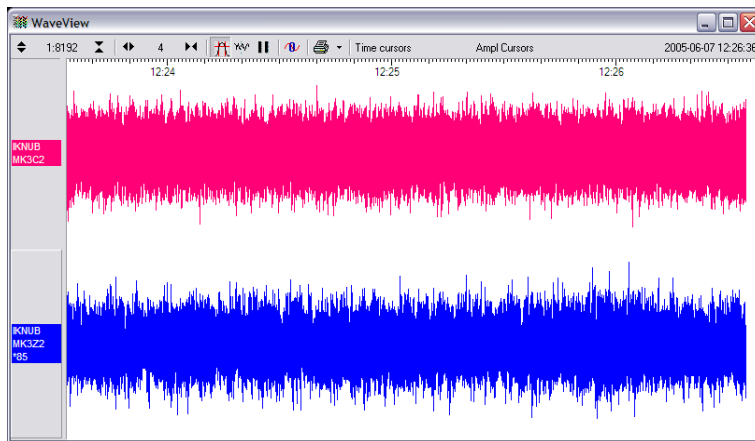

2. Select the calibration channel corresponding to the instrument, and choose **Broadband Noise**. Select the component you wish to calibrate, together with a suitable duration and amplitude, and click **Inject now**. A new data stream, ending $C_{\underline{n}}$ ($\underline{n} = 0 - 7$) or MB, should appear in Scream!'s main window containing the returned calibration signal.



- Open a Waveview window on the calibration signal and the returned streams by selecting them and double-clicking. The streams should display the calibration signal combined with the sensors' own measurements. If you cannot see the calibration signal, zoom into the Waveview using the scaling icons at the top left of the window or the cursor keys.

Drag the calibration stream C_n across the Waveview window, so that it is at the top.

- If the returning signal is saturated, retry using a calibration signal with lower amplitude, until the entire curve is visible in the Waveview window.
- If you need to scale one, but not another, of the traces, right-click on the trace and select **Scale...**. You can then type in a suitable scale factor for that trace.
- Pause the Waveview window by clicking on the  icon.
- Hold down the shift key () and drag across the window to select the calibration signal and the returning component(s). Release the mouse button, keeping **SHIFT** held down. A menu will pop up. Choose **Broadband Noise Calibration**.

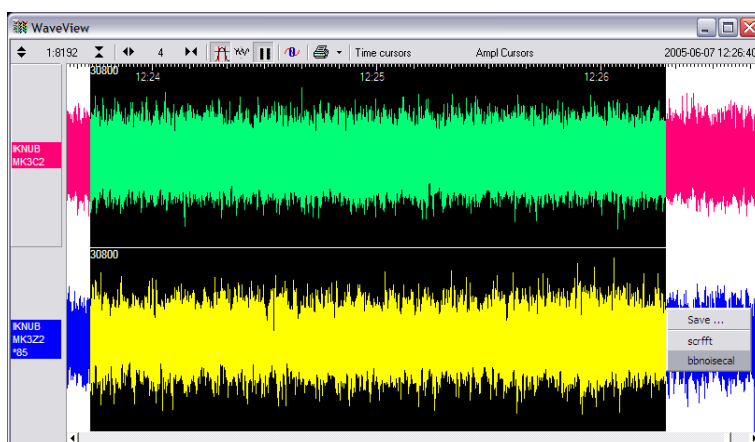

- The script will ask you to fill in sensor calibration parameters for each component you have selected.

Most data can be found on the calibration sheet for your sensor. Under *Instrument response*, you should fill in the sensor response code for your sensor, according to the table below. *Instrument Type* should be set to the model number of the sensor.

If the file `calvals.txt` exists in the same directory as Scream!'s executable (`scream.exe`), Scream! will look there for suitable calibration values. See the Scream! documentation for more information.

- Click . The script will return with a graph showing the responsivity of the sensor in terms of amplitude and phase plots for each component (if appropriate.)

The accuracy of the results depends on the amount of data you have selected, and its sample rate. To obtain good-quality results at low frequency, it will save computation time to use data collected at a lower sample rate; although the same information is present in higher-rate streams, they also include a large amount of high-frequency data which may not be relevant to your purposes.

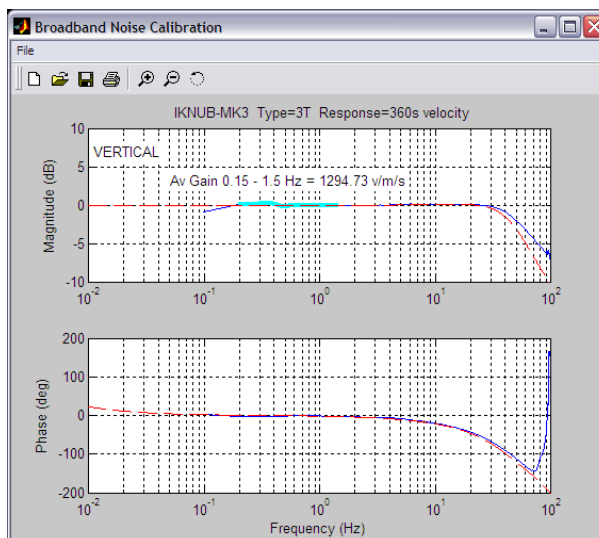

The `bbnoisecal` script automatically performs appropriate averaging to reduce the effects of aliasing and cultural noise.

5.3.1 Sensor response codes for 3TB instruments

Sensor	Sensor type code	Units (V/A)
30 s – 50 Hz response	CMG-3B_30S_50HZ	V
100 s – 50 Hz response	CMG-3B_100S_50HZ	V
120 s – 50 Hz response	CMG-3B_120S_50HZ	V
360 s – 50 Hz response	CMG-3B_360S_50HZ	V
360 s – 100 Hz response	CMG-3B_360S_100HZ	V

5.4 Calibration with a hand-held control unit

If you prefer, you can inject your own calibration signals into the system through a hand-held control unit. The unit includes a switch which activates the calibration relay in the seismometer, and 4 mm banana sockets for an external signal source.

As above, the equivalent input velocity for a sinusoidal calibration signal is given by

$$v = V / 2 \pi f R K$$

where V is the peak-to-peak voltage of the calibration signal, f is the signal frequency, R is the magnitude of the calibration resistor and K is the feedback coil constant. R and K are both given on the calibration sheet supplied with the 3TB.

The calibration resistor is placed in series with the transducer. Depending on the calibration signal source, and the sensitivity of your recording equipment, you may need to increase R by adding further resistors to the circuit.

5.5 The coil constant

The feedback coil constant K is measured at the time of manufacture, and printed on the calibration sheet. Using this value will give good results at the time of installation. However, it may change over time.

The coil constant can be determined by tilting the instrument and measuring its response to gravity. To do this, you will need a mounting harness for the sonde and apparatus for measuring tilt angles accurately.

1. Measure the acceleration due to gravity, g , at your location.
2. Tilt the instrument slightly, and measure its attitude and the gain of the *mass position* output for the component you wish to calibrate.

3. Repeat this measurement for several tilt angles.
4. For the vertical sensor, the input acceleration is given by $a = g \sin \varphi$, whilst for the horizontal sensor, it is $a = g (1 - \cos \varphi)$.

Calculate the input acceleration for each of the tilt angles used, and plot a graph of mass position output against input acceleration.

5. The gradient of the line obtained gives the sensitivity of the coil (in $V/m/s^2$, if g was measured in m/s^2 and the mass position in V.)
6. The coil constant K is equal to this sensitivity divided by the value of the displacement feedback resistor, given on the calibration sheet.

6 Inside the 3TB

6.1 The sensors

The horizontal and vertical sensors are similar in design. The inertial mass in both cases consists of a transducer coil and a leaf-spring suspended boom which swings on a frictionless hinge. A triangular spring supports the weight of the mass; in the vertical sensor this spring is pre-stressed, with a natural period around 0.5 s, whilst the horizontal sensor has an unstressed flat spring with a natural period around 1 s. 3TB sensors have no spurious resonances below 140 Hz, and weigh around 180 g. The small boom size and stiff springs allow three independent instruments to be mounted within the casing, together with all the associated feedback electronics.

The sensor and hole-lock units are stacked one on top of the other with a set of accurately-machined stacking tubes, which also form part of the sensor's pressure housing. Fixing holes provided on each end face allow for simple and accurate assembly. The base of each unit includes a double "O" ring to isolate the sensor from any pressure variations in the atmosphere.

The 3TB functions by monitoring the position of each mass with a capacitive position sensor. The three sensors are identical. Signals from the sensors are fed into an electronic processing unit, which is mounted in a screened compartment above the mechanical components (see below for details on the feedback circuitry.)

When the instrument is being transported, the masses are locked securely in their frames so as to relieve strain on the support hinges. This locking is performed by a small motor-driven clamp in response to a signal from the surface controller unit.

Before using the instrument, the boom of the vertical sensor must be levelled and the bases of the horizontal sensors tilted, so that the masses are centred in their equilibrium positions. These adjustments are made by small DC motors controlled remotely.

See section 4 on page 21, "Installing the 3TB in a borehole" for detailed instructions on how to set up your 3TB installation.

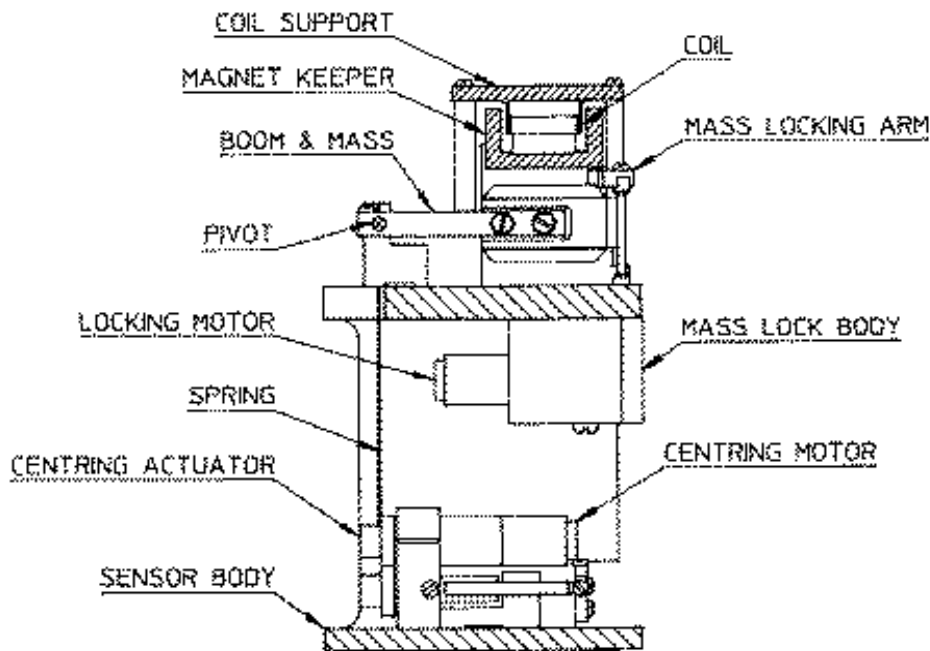
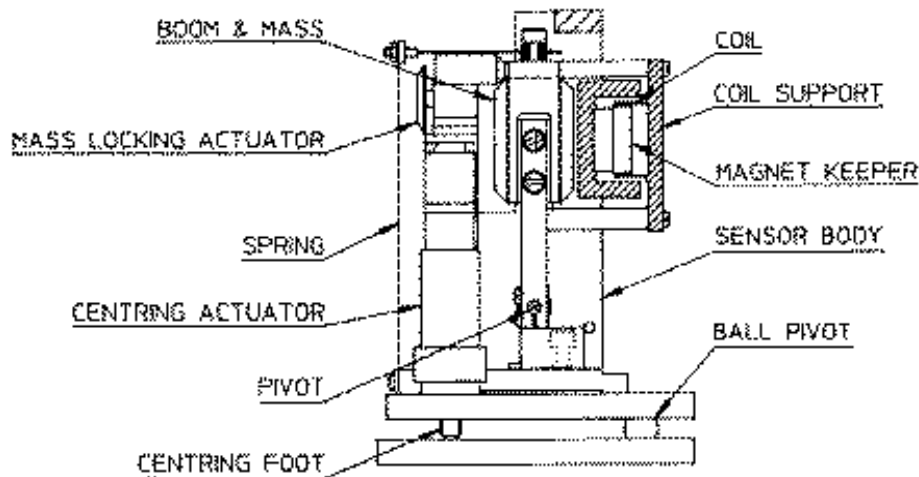

The signal voltages output by the 3TB are proportional to ground velocity, and are transmitted from the instrument on balanced differential lines. In addition, mass position signals are sent as single-ended circuits referred to analogue ground on the output plug. The 3TB also receives control signals, which are used to clamp and un-clamp the masses, and to run the motors which level and centre the instrument once in position. Finally, a line is provided for you to apply a calibrating voltage to the force transducers, thereby measuring the deflection sensitivity.

6.2 The control system

The internal operations of the 3TB are supervised by a control microprocessor, which drives the mass clamping and centring adjustment motors. It responds to

commands sent on three input lines by grounding one (to digital ground) for 0.2 – 7 seconds.

The signals you can send to the microprocessor are termed *LOCK*, *UNLOCK*, and *CENTRE*. Each command acts on the vertical, N/S and E/W masses in turn. The microprocessor prevents the system from attempting incompatible actions (e.g. centring when the masses are clamped.)

While a command is taking place, the *BUSYLED* will flash; you can use this for diagnostic purposes. See the description of each command for full details.

When no command is active, *i.e.* all three lines are high, the control microprocessor goes into a power-saving mode. In routine operation, the lines are controlled from the break-out box, Hand-held Control Unit or digitizer. If you send control signals to the 3TB manually, you must ensure that the lines are allowed to float high after sending the signal, or the equipment may be damaged. A “biased-OFF” type switch can be used for this purpose.

6.2.1 LOCK

This command unlocks the masses and clamps the horizontal sensors by tilting them up to their end stops.

If *LOCK* is activated when the masses are already locked, the processor will unlock them and attempt to lock again. This is useful if you suspect that the locking procedure has failed.

In detail, the process acts as shown in the following graph. The top three streams are the *mass position* outputs of each component (Z, N/S and E/W, respectively), whilst the bottom one represents the state of the *BUSYLED* (up = on).

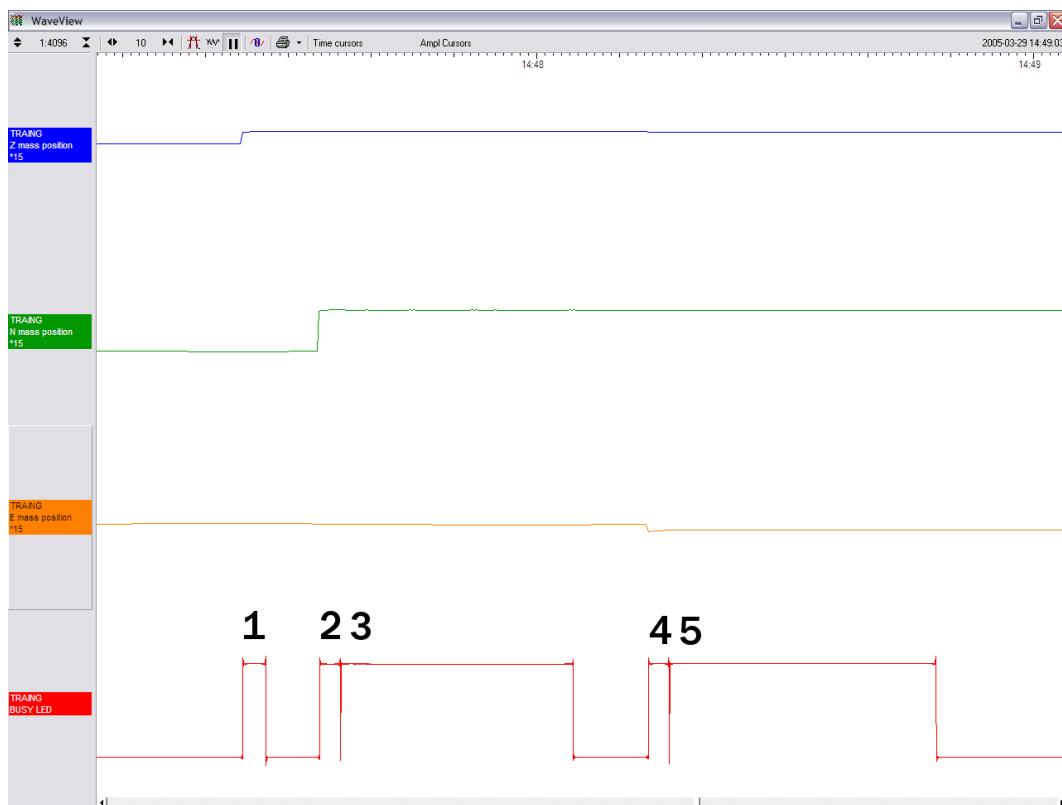

In the five-stage process, each mass in turn is locked with a motorised micrometer (stages 1, 2, 4), and the *N/S* and *E/W* sensor bases are tilted to their end stops (stages 3 and 5). At some point during each tilting stage, the position of the relevant mass will flip to one or other side.

The *BUSYLED* is lit during each stage, but goes out briefly between stages, allowing you to follow the progress of the lock.

6.2.2 UNLOCK

This command unlocks the sensor masses and prepares the instrument to begin operating.

If *UNLOCK* is activated when the masses are already unlocked, the processor will lock them and attempt to unlock again. This is useful if you suspect that the locking procedure has failed.

During the *UNLOCK* procedure, the instrument automatically performs a round of centring for each component.

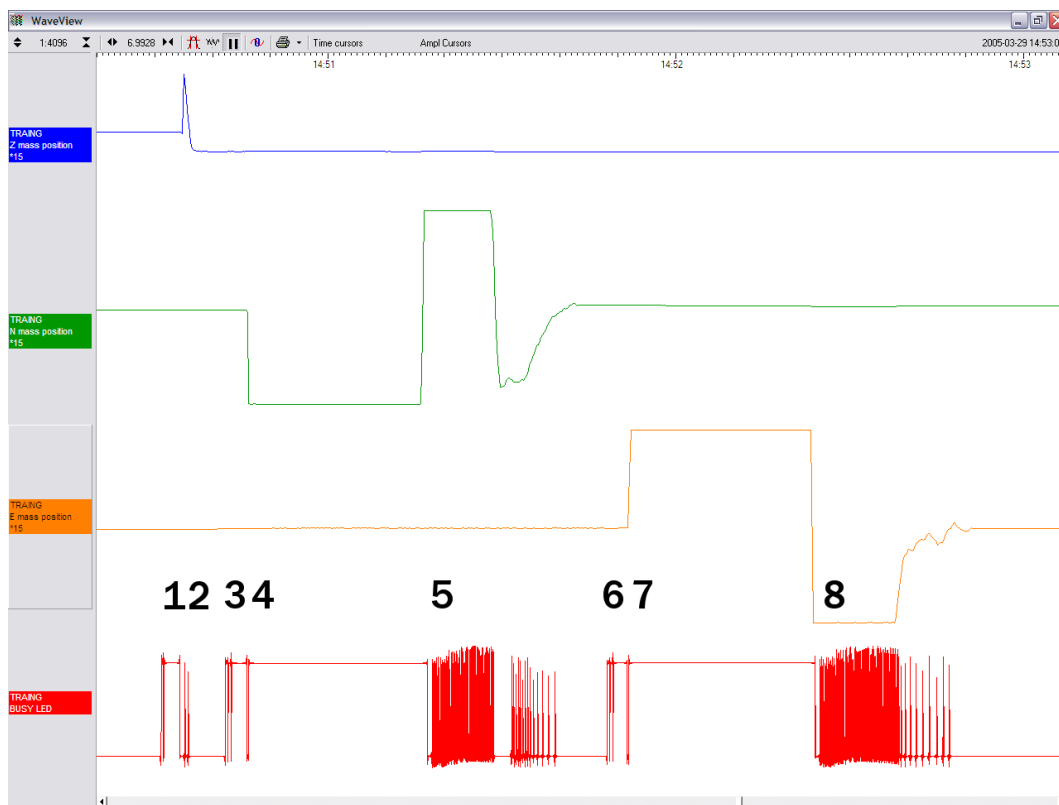

Again, you can use the *BUSYLED* to monitor the progress of unlocking.

1. The instrument checks to see whether the vertical mass is locked, and unlocks it if necessary.
2. The vertical mass is centred by applying pulses to the motor. This stage is often very short, since the vertical mass is locked near its central position.
3. The instrument checks the N/S sensor and base, and unlocks the sensor.
4. The N/S sensor base is tilted to its level position. This process takes rather longer. At some point during this stage, the mass may flip to the other side (as seen in the green trace.)
5. The N/S sensor mass is centred by applying pulses to the motor. This stage will take longer than stage 2, since it must move the mass all the way from its end stop. As the mass nears the centre, the control circuit spaces out the pulses.
6. The E/W component is checked and unlocked.
7. The E/W sensor base is tilted to its level position as in step 4.
8. The E/W sensor mass is centred as in step 5.

After unlocking, the instrument automatically performs a round of centring (see below).

6.2.3 CENTRE

This command re-centres the masses. If the masses are clamped, or if the sensor mass positions do not exceed ± 1.2 V, the *CENTRE* command does nothing. Otherwise, it attempts to zero the output of the vertical, N/S and E/W sensors in sequence by exerting small extra forces on the boom. For the vertical sensor, a motor-driven adjuster presses a small spring lever against the boom until the mass position sensor indicates an offset close to zero. In the case of the horizontal sensors, the sensor frame is tilted on its base plate. Again, the controller monitors the mass position sensor and stops the centring process once it reaches its lowest offset.

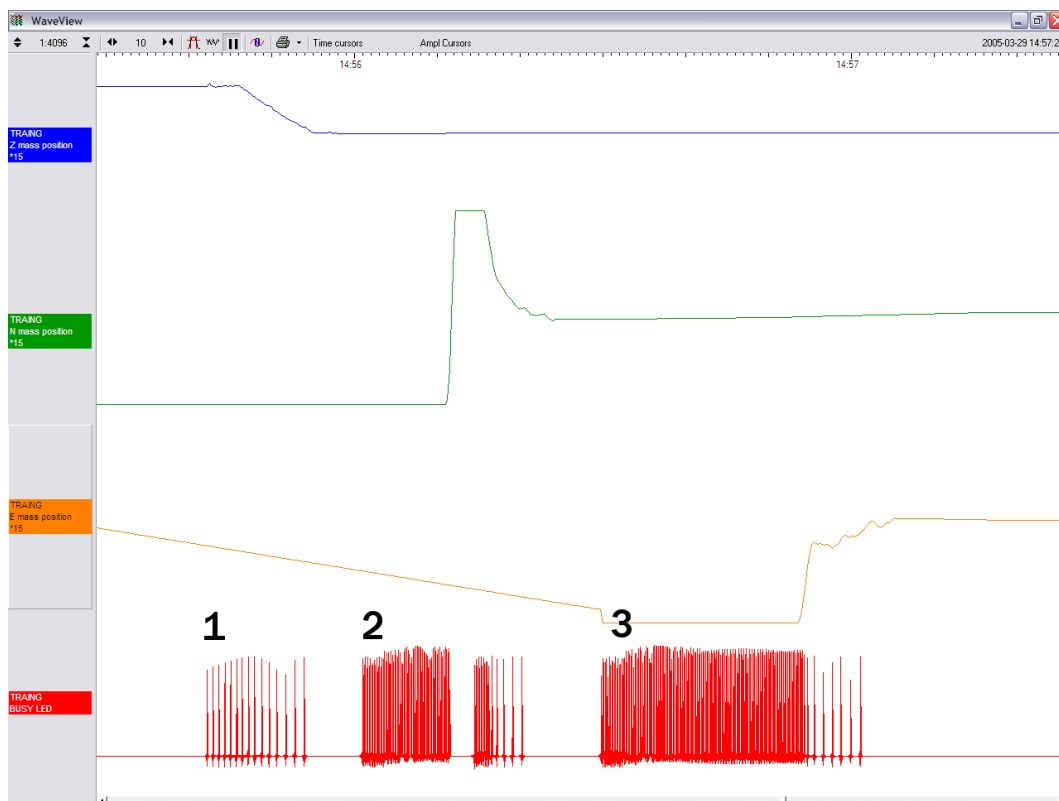

This graph shows a typical centring process:

1. The *BUSYLED* pulses to indicate that it is centring the Z component. Each pulse corresponds to a small force on the mass. The pulses become more spaced out as this goes on, until a pulse is missed, signifying that no corrective impulse is needed.
2. The N/S component follows in the same way. The mass position output does not change for a while, as the true mass position is outside the range of the output. In this case, the pulses cause the mass to overshoot the central position, and a second group of pulses in the opposite direction is applied to bring it into line.

3. The E/W component follows in the same way. All three masses are now centred and the process completes.

After the sensor unlocks the masses, the first round of centring has to move the N/S and E/W components all the way from their end stops, whilst the Z component is often closer to the proper position. Because of this, the first Z centring operation takes much less time than the others, and you may not notice it.

After successful centring, the mass position outputs should be in the range 0.1 – 0.8 Volts. If the centring process leaves the mass position outputs above ± 1.1 Volts, you should start another centring cycle by activating the *CENTRE* command again. You will probably need to initiate the centring process several times before the masses are adequately centred.

6.3 The feedback system

The output from a modern broadband seismometer does not depend on the natural characteristics of the instrument. Instead, the period and damping of the sensor are completely determined by a feedback loop which applies a force to the sensor mass opposing any motion. The force required to *restrain* the movement of the mass can then be used to measure the inertial force which it exerts as a result of ground motion.

All Güralp 3 series units are based on these general principles. The capacitive position sensor for each mass produces a voltage proportional to the displacement of the mass from its equilibrium position. After amplification, this voltage generates a current in the force transducer coil which tends to force the mass back toward equilibrium. The feedback loop has a sufficiently high gain to cancel the motion of the mass. Since the mass is not moving, the forces acting on it must be balanced; the feedback voltage then directly measures the force, and hence the acceleration, which is being applied to the mass. The feedback loop introduces a phase shift, which must be carefully controlled if the instrument is to remain stable over its entire frequency range. This is achieved using compensation components in the forward and feedback paths.

Force feedback seismometers of this type rely on the assumption that the force transducer produces a field of constant strength. The magnetic circuit and magnet/pole assembly in the 3TB are designed so that the field strength from the feedback transducer is constant over large deflections and current levels. Tests have shown that the mechanical suspension system and electronics of a 3TB instrument are linear to better than 107 dB (source: measurements made at ASL during evaluation for the USGS National Network.)

In a feedback seismometer with a displacement transducer, it is essential to monitor the acceleration (mass position) output. This provides the position of the displacement transducer and therefore also the mass position, as the displacement transducer is attached to the sensor inertial mass. The sensor should always be

operated with the displacement transducer centred or nulled, so that the response to input acceleration is linear.

There are two types of feedback system which can be used in a 3TB instrument, known as *hybrid* and *conventional-response* feedback.

6.3.1 Hybrid feedback

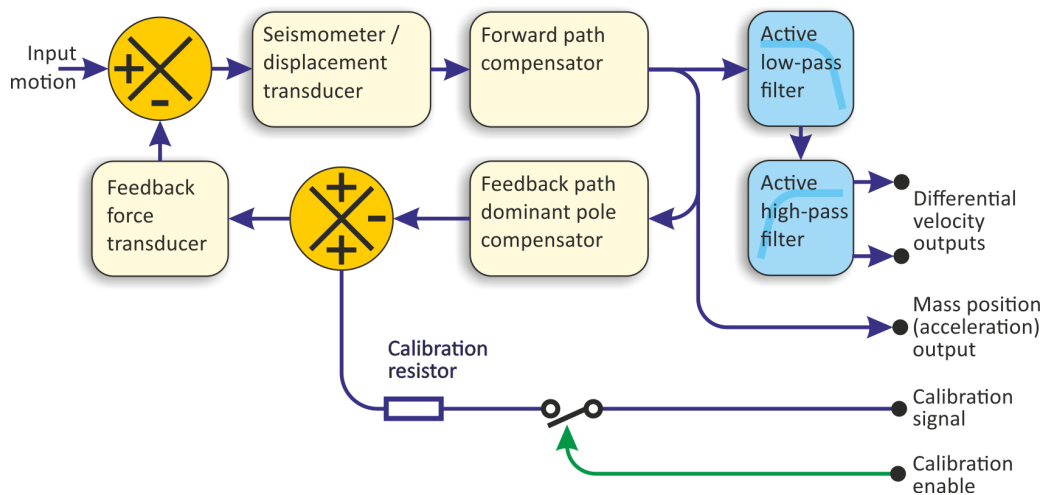

The *hybrid* feedback circuit contains a single capacitor in parallel with a resistor, resulting in a single dominant pole at 0.033 Hz (30 s). Below this frequency, the response of the seismometer is flat to ground acceleration; above it, the response is flat to velocity. (Other values for the acceleration-velocity corner can be provided upon request.) Hybrid-feedback systems provide a stable response, particularly for portable systems, with a high saturation level at high frequencies and a high dynamic range at long periods.

An active low-pass filter provides a high-frequency cut-off point at a frequency you specify. Without the filter, the velocity response is flat up to 100 Hz. Outside the feedback loop there is an active high-pass filter with a corner frequency of 0.01 Hz (100 s) or 0.005 Hz (200 s), which serves to remove any DC offsets.

6.3.2 Conventional-response feedback

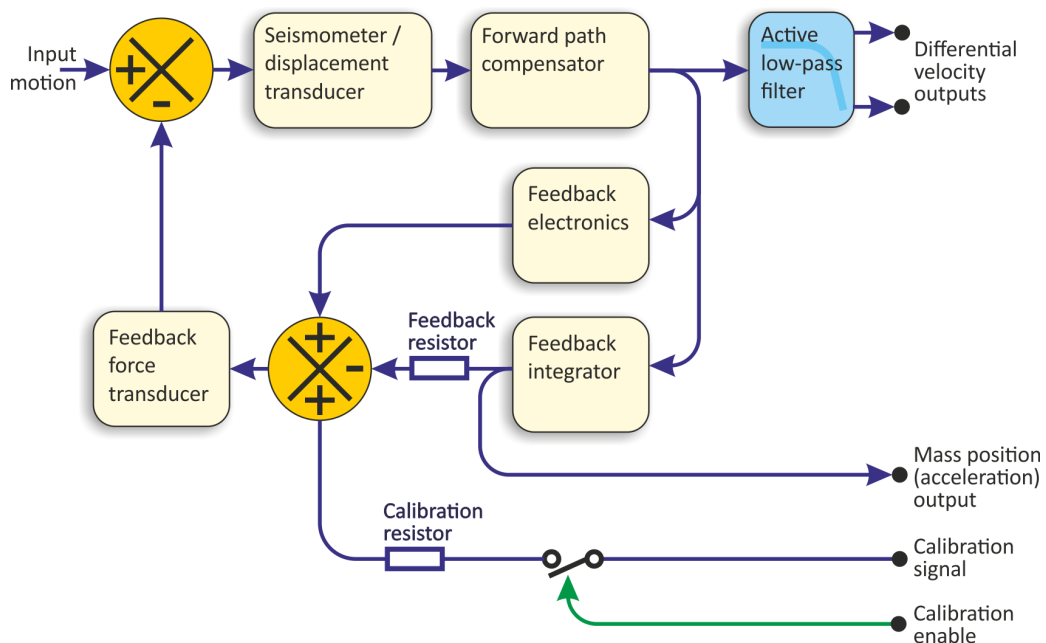

The *conventional-response* feedback system has an additional parallel feedback circuit, consisting of a non-inverting integrator in series with a resistor. This arrangement results in two poles at specified frequencies. The velocity response of a conventional-response system is defined by a transfer function identical to that of a conventional long-period sensor with a damping constant ζ of 0.707 ($1/\sqrt{2}$)

The seismometer can be supplied with an equivalent resonant frequency of 0.033 Hz (30 s), 0.01 Hz (100 s) or 0.0083 Hz (120 s) as required. An active low-pass filter provides a high-frequency cut-off point at a frequency you specify.

6.3.3 Comparisons

The figures below plot the comparative response of a conventional velocity output broadband sensor and a hybrid output broadband sensor. The upper graph shows the response in terms of output against input acceleration in units of V/ms^{-2} , whilst the lower graph is plotted in terms of output against input velocity, in V/ms^{-1} .

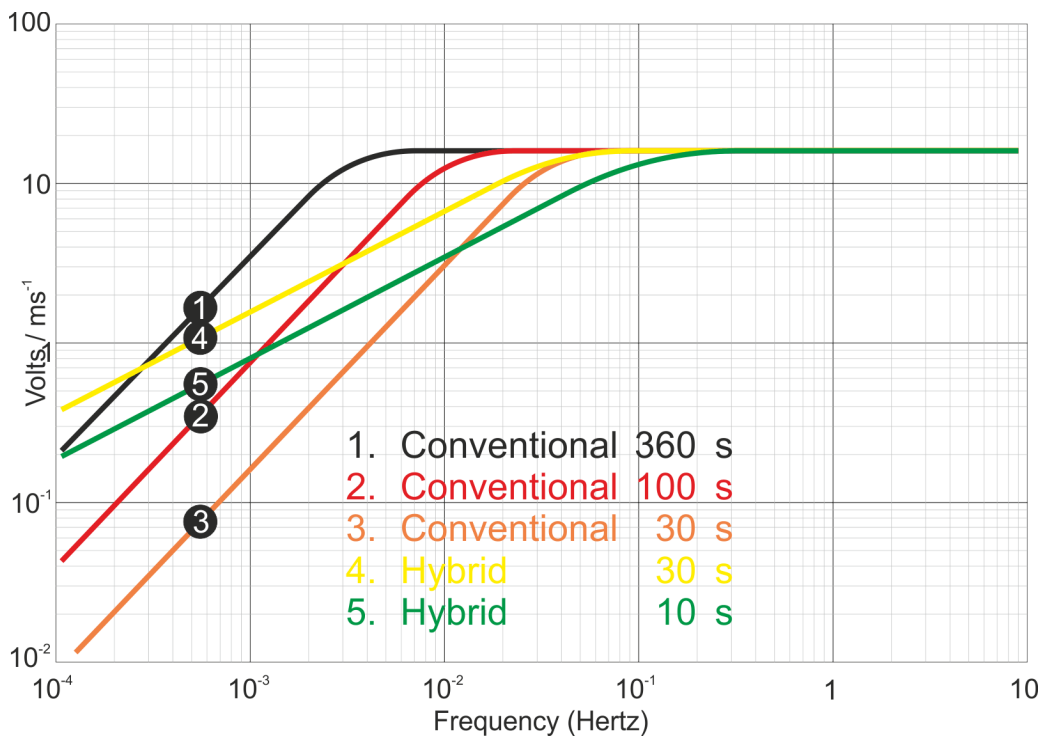
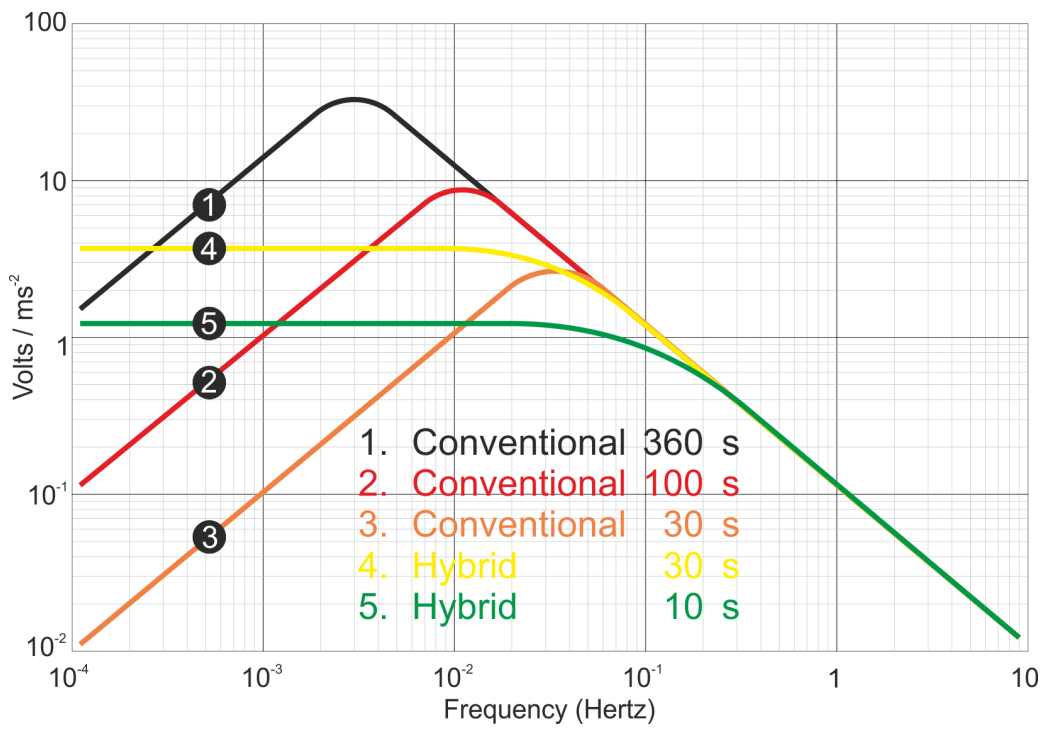

7 Connector pin-outs

7.1 Break-out Box – Power connector

These are standard 10-pin “military-specification” sockets, conforming to MIL-DTL-26482 (formerly MIL-C-26482). A typical part-number is 02E-12-10S although the initial “02E” varies with manufacturer.

Suitable mating connectors have part-numbers like ***-12-10P and are available from Amphenol, ITT Cannon and other manufacturers.



Pin	Function
A	Power supply 0 V
B	Power supply: +ve (12-24 V DC)
C	<i>not connected</i>
D	<i>not connected</i>
E	Digital ground
F	Hole-lock motor
G	<i>not connected</i>
H	<i>not connected</i>
J	<i>not connected</i>
K	Hole-lock motor return

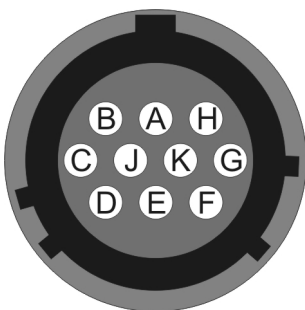

Wiring details for the compatible plug, ***-12-10P, as seen from the cable end (*i.e.* when assembling).

7.2 Break-out Box – Recorder and Control connectors

This is a standard 26-pin “military-specification” plug, conforming to MIL-DTL-26482 (formerly MIL-C-26482). A typical part-number is 02E-16-26P although the initial “02E” varies with manufacturer.

Suitable mating connectors have part-numbers like ***-16-26S and are available from Amphenol, ITT Cannon and other manufacturers.



Pin	Function	Pin	Function
A	Velocity, non-inverting – Z	P	Calibration signal (all channels)
B	Velocity, inverting – Z	R	Calibration enable (all channels)
C	Velocity, non-inverting – N/S	S	Inclinometer output - X
D	Velocity, inverting – N/S	T	Inclinometer output - Y
E	Velocity, non-inverting – E/W	U	Centre
F	Velocity, inverting – E/W	V	<i>not connected</i>
G	Mass position – Z	W	Unlock
H	<i>not connected</i>	X	Lock
J	Mass position – N/S	Y	Digital ground
K	“Busy” LED	Z	Inclinometer power
L	Mass position – E/W	a	<i>not connected</i>
M	<i>not connected</i>	b	Power supply 0 V
N	Signal ground	c	Power supply: +ve (12-24 V DC)

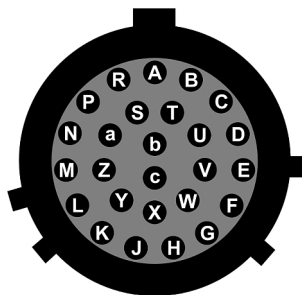

Wiring details for the compatible socket, ***-16-26S, as seen from the cable end (*i.e.* when assembling).

7.3 Break-out Box – Sensor connector

This is a standard 26-pin “military-specification” plug, conforming to MIL-DTL-26482 (formerly MIL-C-26482). A typical part-number is 02E-16-26P although the initial “02E” varies with manufacturer.

Suitable mating connectors have part-numbers like ***-16-26S and are available from Amphenol, ITT Cannon and other manufacturers.



Pin	Function	Pin	Function
A	Velocity, non-inverting – Z	P	Calibration signal (all channels)
B	Velocity, inverting – Z	R	Calibration enable (all channels)
C	Velocity, non-inverting – N/S	S	Inclinometer output - X
D	Velocity, inverting – N/S	T	Inclinometer output - Y
E	Velocity, non-inverting – E/W	U	Centre
F	Velocity, inverting – E/W	V	<i>not connected</i>
G	Mass position – Z	W	Unlock
H	Hole-lock motor	X	Lock
J	Mass position – N/S	Y	Digital ground
K	“Busy” LED	Z	Inclinometer power
L	Mass position – E/W	a	<i>not connected</i>
M	<i>not connected</i>	b	Power supply 0 V and Hole-lock motor return
N	Signal ground	c	Power supply: +ve (12-24 V DC)

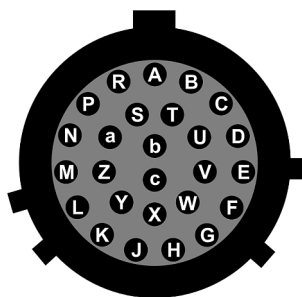

Wiring details for the compatible socket, ***-16-26S, as seen from the cable end (*i.e.* when assembling).

7.4 Instrument - Sensor Connector

This is a custom 32-pin plug with pin spacing and layout conforming to MIL-DTL-26482 (formerly MIL-C-26482). The GSL part number is ELM-32P-18FX+MEC-GEN-1002-32W.



Pin	Function	Pin	Function
A	Hole-lock motor	T	Inclinometer output - Y
B	Hole-lock motor return	U	Inclinometer output - X
C	Inclinometer power	V	Centre
D	Power supply: +ve (12-24 V DC)	W	"Busy" LED
E	Power supply: 0 V	V	<i>not connected</i>
F	Mass position - Z	Y	Lock
G	Mass position - N/S	Z	Unlock
H	Mass position - E/W	a	<i>not connected</i>
J	Velocity, non-inverting - Z	b	Acceleration/Velocity mode
K	Velocity, inverting - Z	c	<i>not connected</i>
L	Velocity, non-inverting - N/S	d	<i>not connected</i>
M	Velocity, inverting - N/S	e	Signal ground
N	Velocity, non-inverting - E/W	f	Digital ground
P	Velocity, inverting - E/W	g	<i>not connected</i>
R	Calibration signal (all channels)	h	<i>not connected</i>
S	Calibration enable (all channels)	j	Case ground

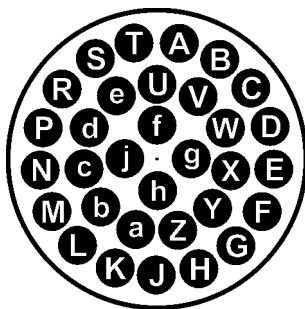

Wiring details for the compatible socket, MEC-GEN-2002-32W, as seen from the cable end (*i.e.* when assembling).

8 Specifications

Hybrid sensors	Velocity output bandwidth	0.1 – 50 Hz
	High pass filter output flat to acceleration	0.01 Hz – spec*
	High pass filter output flat to velocity	spec – 50 Hz*
	Mass position output	DC – 0.1 Hz
	Velocity sensitivity	1400 V/ms ⁻¹
	Acceleration sensitivity	2000 V/ms ⁻²
Velocity sensors	Velocity output bandwidth	spec – 50 / 100 Hz*
	Mass position output	DC – spec Hz*
Controls	Velocity sensitivity	2 × 1000 V/ms ^{-1**}
	Mass position sensitivity	1000 V/ms ⁻²
	Mass locking and unlocking	remotely operated
	Mass centring	microprocessor controlled
Mechanics and electronics	Sensors	3 orthogonal sensors, each 0.180 kg
	Lowest spurious resonance	above 140 Hz
	Sensor transducer type	capacitive displacement
	Feedback transducer type	magnet/coil
Power	Connector	Waterproof, bayonet
	Borehole diameter	89 – 229 mm
	Temperature range (masses locked)	–20 to +75 °C
	Operational temperature range	–10 to +65 °C
	Supply requirements	11 – 36 V DC
	Current at 24 V DC	75 mA†
	Current at 24 V DC during centring (average)	115 mA†
	Current at 24 V DC during locking and unlocking	200 mA†

See following notes:

* spec refers to the quoted frequency response value, e.g., for a “30 s” sensor, the value of spec would be $30 \text{ s} = 0.033 \text{ Hz}$.

** Sensors are available with a range of sensitivities between 2×750 and $2 \times 10,000 \text{ V/ms}^{-1}$

† Because centring, locking, and unlocking consume varying amounts of power, it is recommended that you use a power supply capable of delivering 1 A at 12 V.

9 Revision history

2019-11-13	G	Amended diameter. Replaced orientation chapter. Updated images
2018-03-12	F	Removed "direct" from pin-outs
2017-11-06	E	Added baffle details
2016-01-02		Face-lift with no significant content changes
2013-04-17	D	Added surge arrestor/stress relief details
2006-11-15	C	Updated Scream! and SOH; added revision history
2005-05-12	B	Original document